

‘Express Forwarding’: A Distributed QoS MAC Protocol for Wireless Mesh

Mathilde Benveniste, Ph.D.
benveniste@ieee.org

Mesh 2008, Cap Esterel, France

Abstract

- Abundant hidden node collisions and correlated channel access due to **multi-hop flows degrade QoS** in wireless mesh networks using a single channel
- QoS in nearby WLANs operating on the same channel is also affected
- We propose the following enhancements for mesh channel access:
 - *wider retransmit contention windows* for backoff to lower the risk of repeated hidden-node collisions
 - a spatial extension of the TXOP concept called '*express forwarding*' to clear multi-hop flows sooner
 - a new mechanism called '*express re-transmission*' to reduce collisions on retransmission
- Simulation results show the potential benefit of the proposed enhancements and impact on fairness

Full paper available at: http://www.en-aerion.com/express_forwarding.pdf and through the IEEE Digital Library

Outline

Wireless mesh purpose

Latency requirements for QoS traffic

Hidden node collisions in mesh

Background: EDCA

Proposed MAC remedies

- Express Forwarding

- Express Retransmission

Performance study

Purpose of Wireless Mesh

- What is a wireless mesh?
 - A collection of wireless devices that can communicate with peers in one or multiple hops
- Purpose
 - to extend the area of wireless broadband coverage without wiring (municipalities, public access, office network, and home network)
 - for temporary installation/extension to LAN/WLANs without wiring (military, public safety, emergency and rescue)

Types of Wireless Meshes

- Types of mesh nodes
 - Devices – capable of multi-hop peer-to-peer communication
 - WLAN APs – enable non-mesh devices to join wireless mesh
 - Mesh portal – interface with distribution system
- Types of meshes
 - Single-channel mesh (extends coverage range and increases data rates)
 - Multi-channel (radio) mesh necessary for backhaul of AP traffic
- IEEE 802.11 wireless mesh networks operate on the same RF spectrum as WLANs
 - In 2.4 GHz and 5 GHz unlicensed RF bands

Wireless Mesh in Enterprise

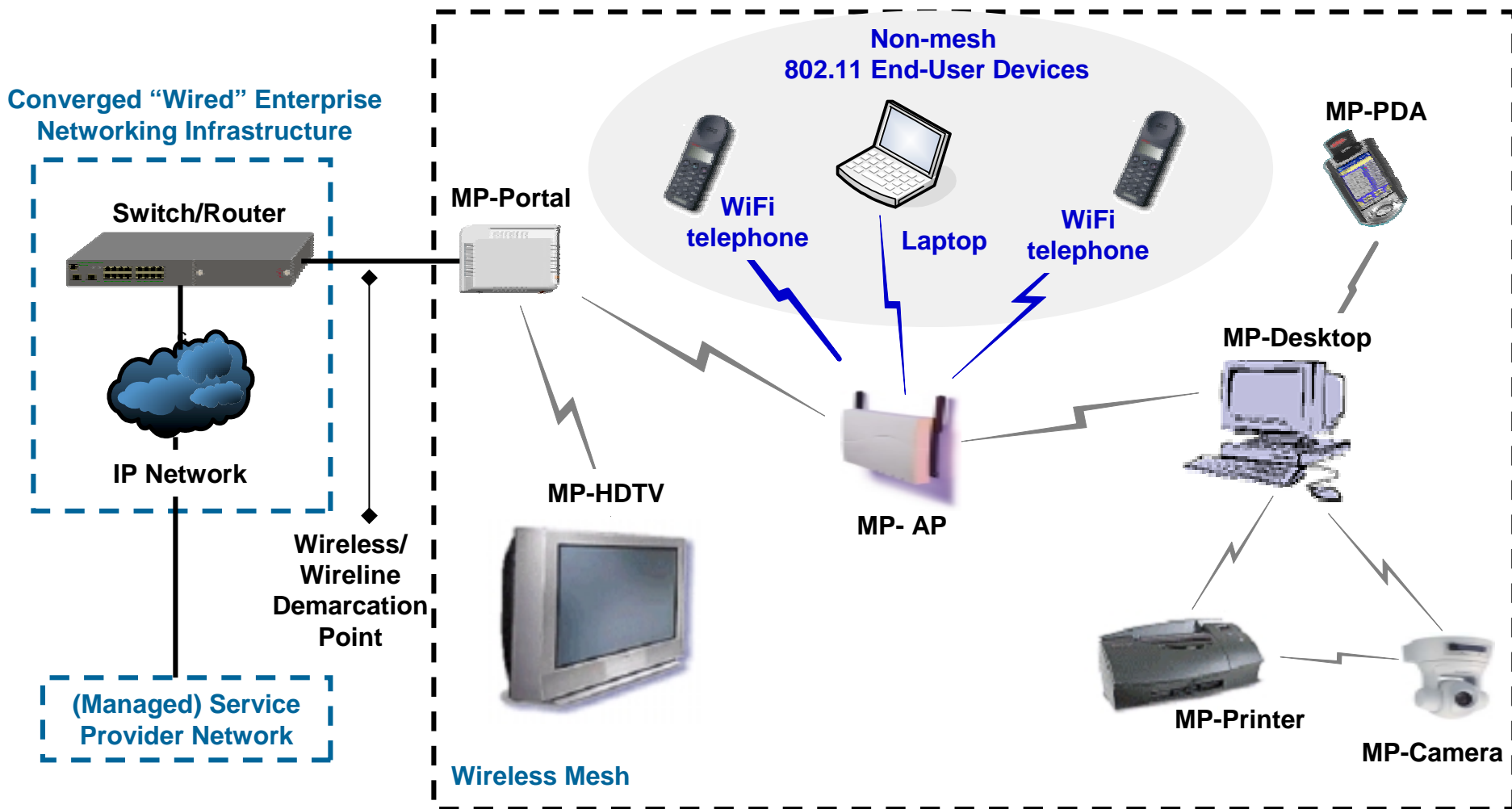

Latency requirements

- Low end-to-end delay/jitter required for VoIP QoS
- **Recommended one-way total delay (ITU G.114) – 150 ms**
 - The target for maximum latency in an infrastructure wireless mesh should be 40 ms
- The use of **EDCA** – the protocol for prioritized access in 802.11e – **has been proposed for mesh**
 - While EDCA can help shorten the delay of QoS-sensitive traffic relative to that of Best Effort traffic, it is not enough
- **Multi-hop transmissions** can make **end-to-end delay/jitter too high** in meshes operating on a single channel
 - Single-hop latencies compound at the least
 - Collisions due to “hidden nodes” increase latencies severely when EDCA or CSMA/CA is used
- **A new MAC protocol is needed**

Hidden node collisions in mesh

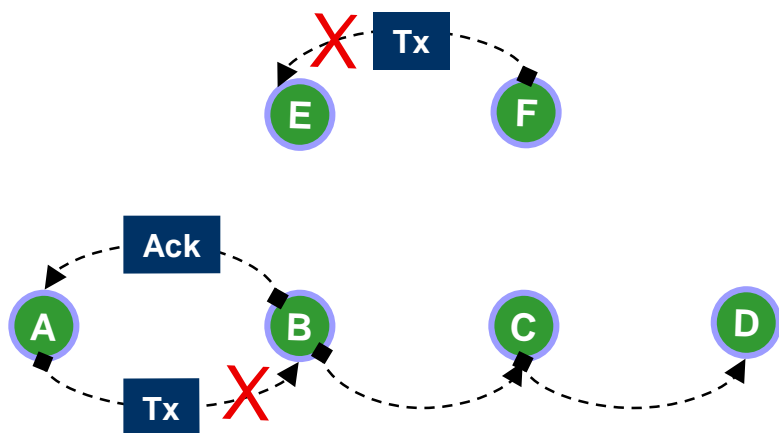

Nodes A and F are 'hidden' from each other by distance

- Node B is unable to decode a transmission from A if it is within interference range of node F
- Hidden node collisions are more prevalent in single-channel meshes than in multi-channel meshes or WLANs
 - Only uplink transmissions have such collisions in an infrastructure WLAN
 - Neighboring WLANs reduce such collisions between them by operating on different channels
- Hidden terminal collisions between two transmissions are likely to repeat

Collisions with multi-hop flows

- An Ack of a multi-hop flow may cause a hidden terminal collision to flows near its path
- Device A, re-trying a failed transmission, must draw a random backoff from a wider contention window
- Devices D and E will complete their transmissions before A retransmits
- The multi-hop flow causes delays to neighboring flows
- The sooner the multi-hop flow completes the sooner A's retransmission will succeed

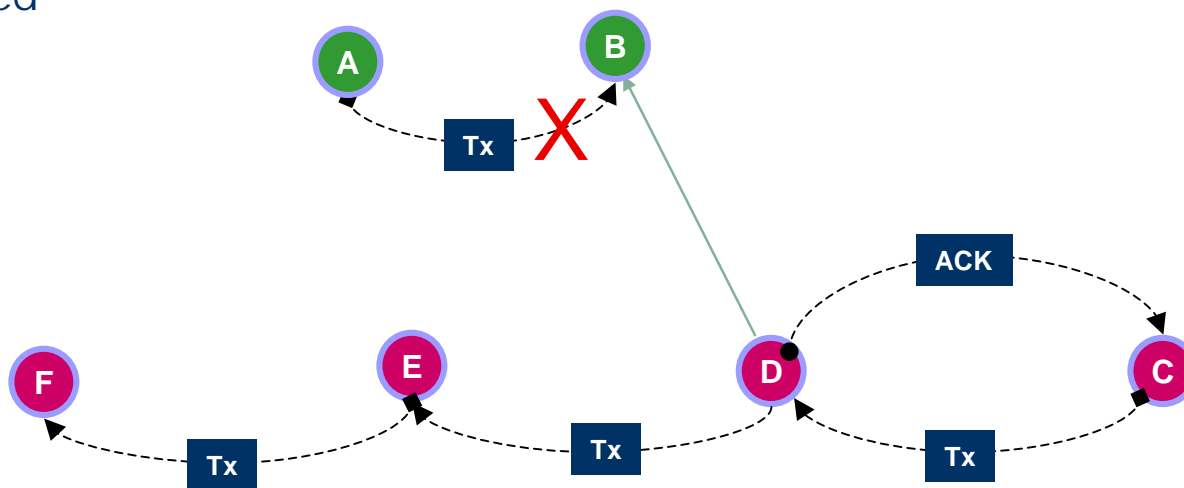

Background: EDCA

Reference: M. Benveniste, "QoS in WLANs", in *Emerging Technologies in Wireless LANs: Theory, Design, and Deployment*, (B. Bing, ed.), Cambridge University Press, 2008, ISBN 978-0-521-89584-2

The 802.11e EDCA MAC protocol, *TCMA (Tiered Contention Multiple Access)*, extends CSMA/CA to provide priority differentiation

- In CSMA/CA, a station **listens before transmitting** packets over the air to ensure channel is not busy
- Stations within interfering range of one another would collide if they transmitted when the medium became idle
- To avoid collisions, each station waits for a period of time, the **backoff delay**, which is selected randomly from a fixed *contention window*, and is counted down only while the medium is idle
- After a medium busy period, a station must wait for the **arbitration interval (AIFS)** with the medium idle before either transmitting packets or resuming backoff count down
- The arbitration interval length varies with the priority of the packet
 - A **shorter arbitration interval** used by **higher-priority** packets
- A device attempting a **failed transmission** must draw a random backoff from a **wider contention window**

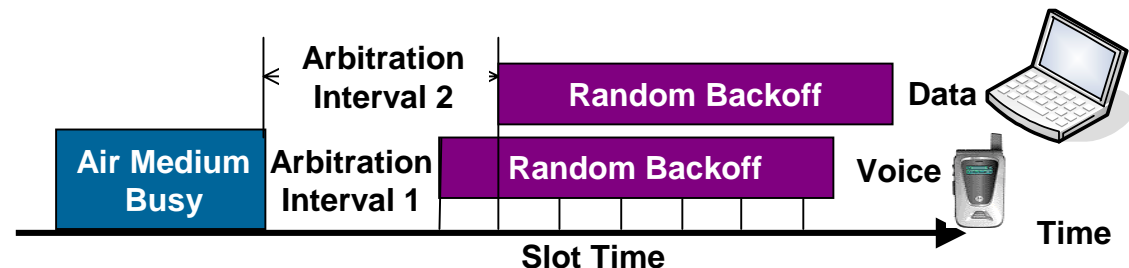

Remedy: Wide ReTx Contention Windows

- Carrier sensing in CSMA/CA or TCMA cannot avert collisions on transmissions by nodes that cannot hear one another
- The collision is likely to reoccur on retransmission as
 - The devices are unable to hear one another
 - Backoff is counted down and may expire while the other device transmits
- Backoff delays must be drawn from wide contention windows upon retransmission to increase the likelihood of avoiding another collision
 - Setting CWmax to a large value is a way to effect this

Remedy: 'Express Forwarding'

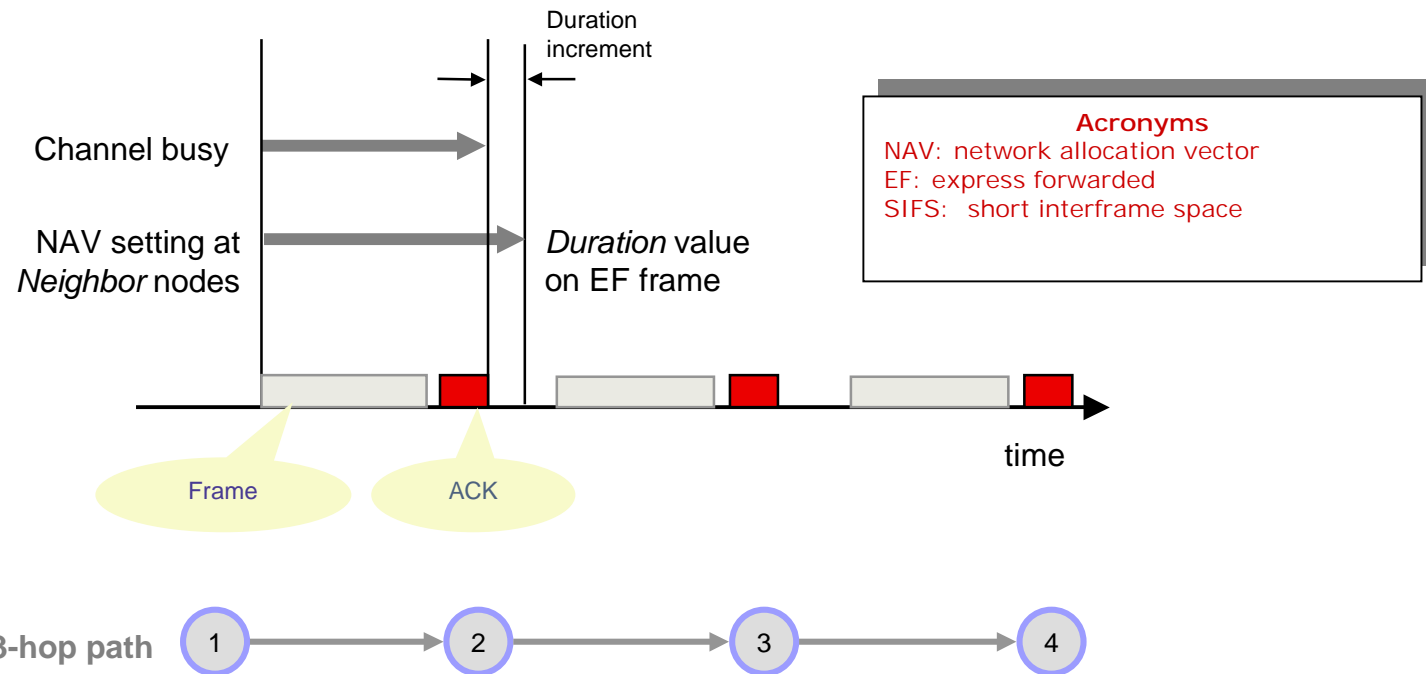

- The Duration field of an EF frame is set at value longer than usual when it is transmitted to a forwarding node of a multi-hop path; the Duration increment is $1 \text{ timeslot} + \max\{0, (\text{IP processing delay} - \text{AckTime} - \text{SIFS})\}$
- The non-forwarding neighbor nodes set NAV according to Duration field
- The forwarding nodes, 2 and 3, can transmit following an idle time of AIFS after receiving the frame, without the need for backoff

Express Forwarding combined with RTS/CTS or TXOPs

- Express forwarding reserves the channel for the transmission on the next hop
- RTS/CTS protect a transmission from collisions due to hidden nodes
- TXOPs also provide protection against hidden node collisions
- Unlike express forwarding, neither RTS/CTS nor TXOPs reserve the channel for the transmission on the next hop
- Express forwarding can be used for the transmission of the RTS and for a TXOP, thus combining their respective benefits

Recognizing EF frames

- By marking a frame as express forwarded (EF) with a special flag, the receiver can prioritize transmission of a TXOP containing the EF frame over other transmissions
- The criteria for EF designation may vary
 - An EF frame can be a frame of a specified user priority (e.g. VO)
 - Express forwarding may be applied only after a frame has traversed a specified number of hops or once a certain time-to-live remains

Remedy: 'Express Retransmission'

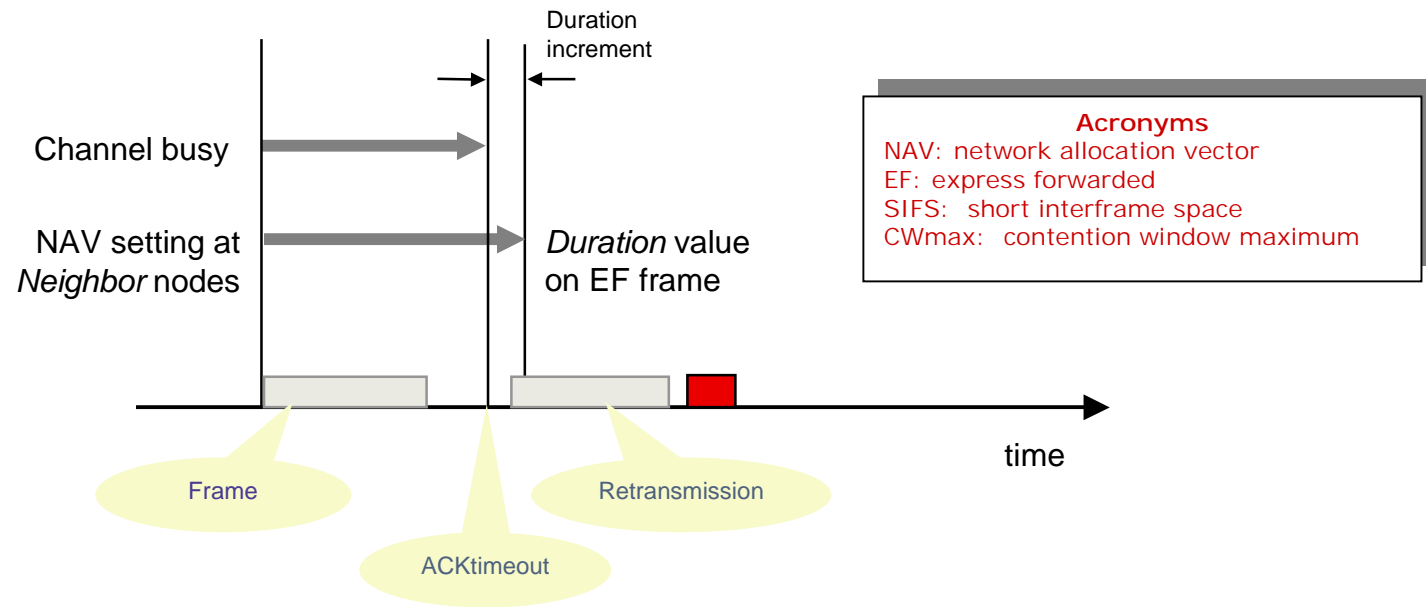

- Retransmission of a failed transmission in EDCA involves backoff from a wider contention window
- With 'express retransmission', the backoff is dispensed with and transmission follows SIFS after AckTimeout
- An express forwarded frame is less likely to collide on retransmission because it is expedited
- Only the first retransmission attempt receives priority treatment
 - Prevents two express-forwarded frames from colliding repeatedly
- Subsequent retransmission attempts less likely to lead to collision when using large CWmax

Performance Study

Overlaid WLANs and wireless mesh

Network configuration

- ❑ TX RANGE: 25 m
- ❑ next-hop neighbors don't hear each other

Traffic description

VIDEO (L): Low Resolution

- ❑ Load: 1.4 Mbps
- ❑ Frame payload: 1464 bytes
- ❑ Inter-arrival 8 ms

VIDEO (H): High Resolution

- ❑ Load: 4.2 Mbps
- ❑ Frame payload: 1464 bytes
- ❑ Inter-arrival 2.83 ms

VOIP: G711

- ❑ Load: 0.16 Mbps
- ❑ Frame payload: 200 bytes
- ❑ Inter-arrival 20 ms

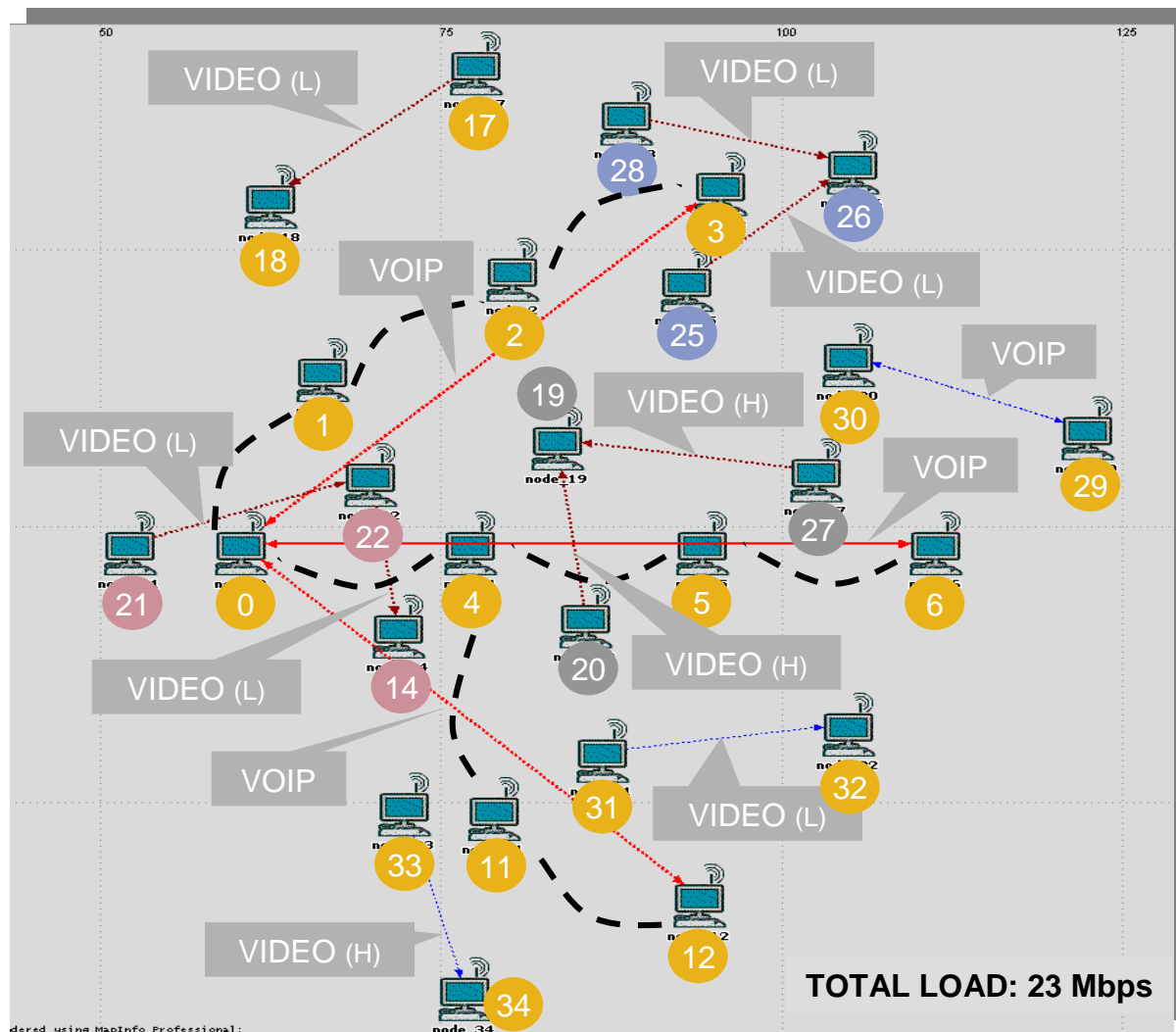

Scenarios

Scenario	Description
1. EF Disabled	Express Forwarding disabled
2. EF Enabled	Express Forwarding enabled for multi-hop flows
3. EF-ERTX Enabled	Express Forwarding & Express Retransmission enabled for multi-hop flows

Performance: Mean delay (ms)

Scenario		EF Disabled	EF Enabled	EF-ERTX Enabled
Flow	Network			
Node 0 – Node 3 (M)	Mesh	22	5	2
Node 3 – Node 0 (M)	Mesh	19	3	2
Node 0 – Node 6 (M)	Mesh	2,698	8	3
Node 6 – Node 0 (M)	Mesh	2,562	4	3
Node 0 – Node 12 (M)	Mesh	3,583	17	6
Node 12 – Node 0 (M)	Mesh	3,448	16	7
Node 17 – node18 (S)	Mesh	12	4	3
Node 29 – Node 30 (S)	Mesh	9	3	3
Node 30 – Node 29 (S)	Mesh	4	3	2
Node 31 – Node 32 (S)	Mesh	8	4	3
Node 20 – Node 19 (S)	WLAN 1	6	4	4
Node 27 – Node 19 (S)	WLAN 1	8	5	5
Node 21 – Node 22 (S)	WLAN 2	4	3	3
Node 22 – Node 14 (S)	WLAN 2	3	2	2
Node 25 – Node 26 (S)	WLAN 3	3	2	2
Node 28 – Node 26 (S)	WLAN 3	3	2	2

Performance: Retransmissions

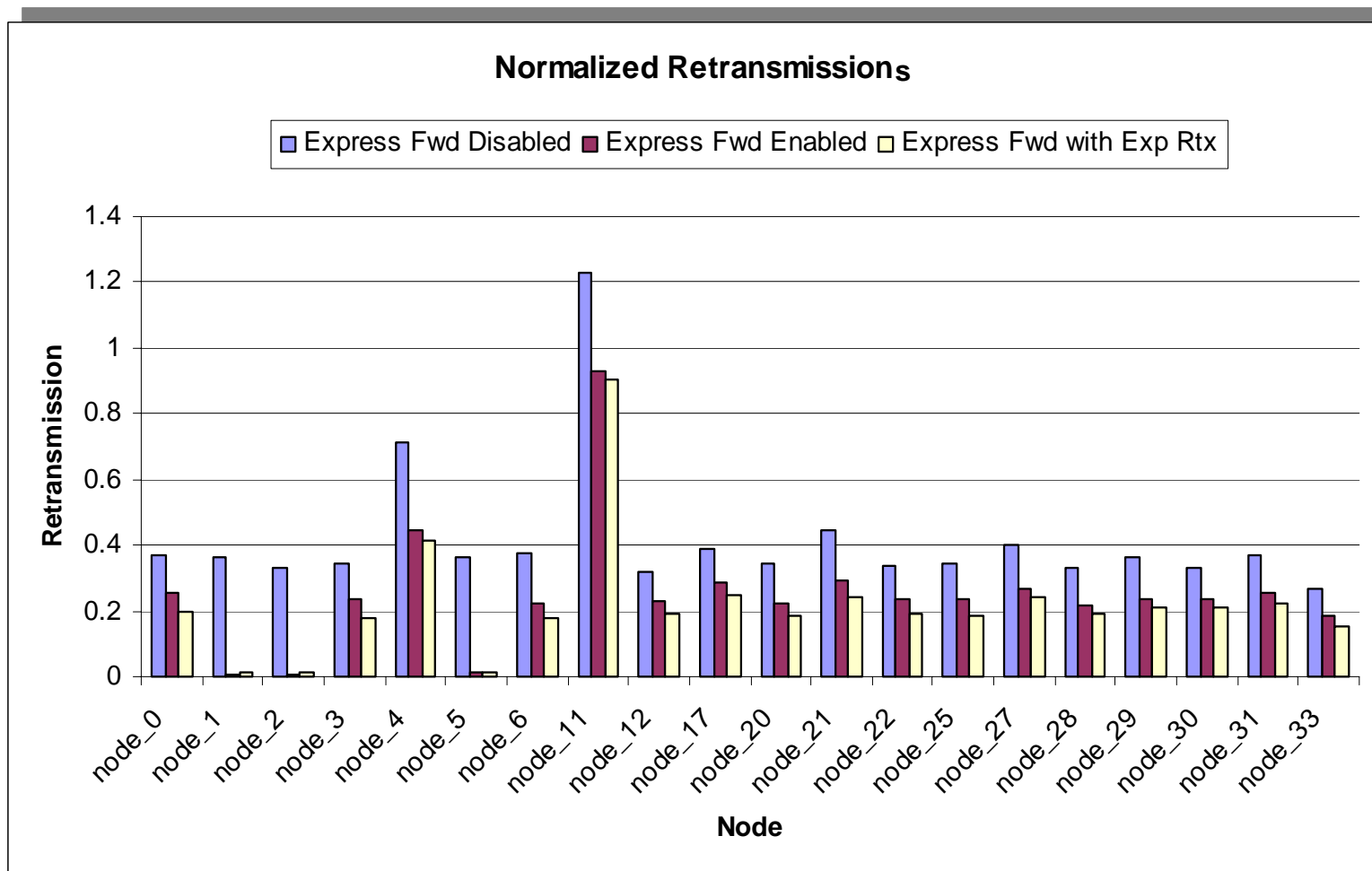

Load 23 Mbps; data @ 54 Mbps; ACK @ 24 Mbps

Performance: Dropped Frames

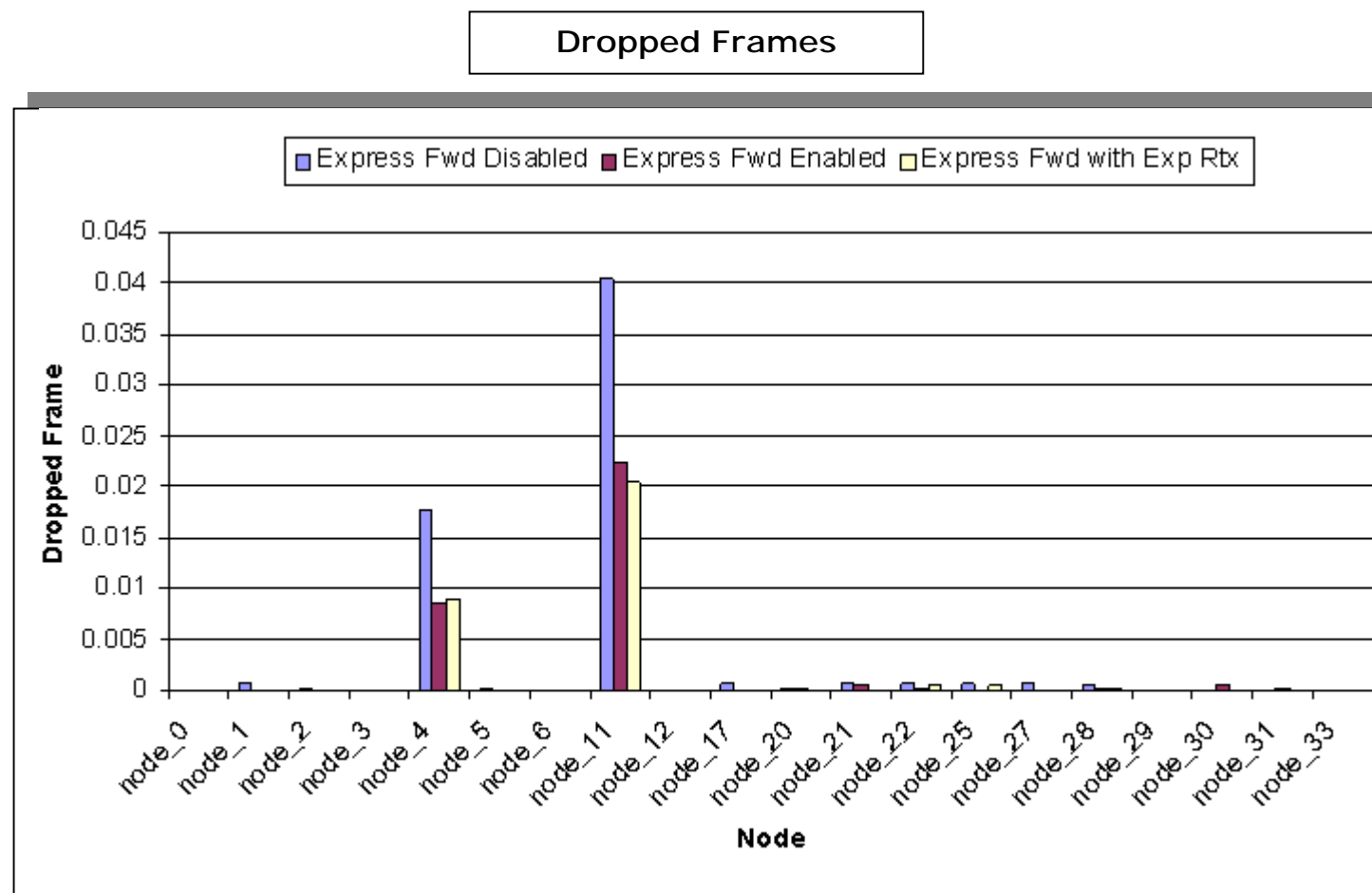

Load 23 Mbps; data @ 54 Mbps; ACK @ 24 Mbps

Fairness considerations

- Express forwarding gives preferential treatment to nodes forwarding multi-hop traffic over nodes that transmit traffic for a single hop
- Since the user's experience is tied to the end-to-end latency, however, fairness should be considered on a per-flow basis
- When analyzing fairness on a per-flow basis, we find that express forwarding is a fair MAC protocol
 - It is fairer than EDCA as it helps reduce multi-hop flow latencies and prevents single hop flows from experiencing longer delays than multi-hop ones

Conclusions

- Express Forwarding expedites multi-hop flows and reduces contention on the channel
- As a consequence it has the following benefits
 - Reduces end-to-end delay and jitter of the multi-hop flows substantially
 - Causes fewer frames to be dropped
 - Other (not express forwarded) traffic also benefits substantially – paradoxical as it may seem
 - Any delay increases on non-express forwarded traffic are small and the resulting single-hop latencies are far shorter than the multi-hop latencies
- Express Retransmission further enhances these benefits
- Together they were able to deliver delay performance that meets the QoS requirements for real-time applications, while EDCA could not
- Their impact on other traffic (WLAN and mesh) was minimal
- From the end-user's perspective, express forwarding is fairer than EDCA as it helps reduce multi-hop flow latencies substantially without increasing delays of single hop flows excessively

References

- 1) IEEE Standard for Wireless LAN Medium Access Control (MAC) and Physical (PHY) Layer Specifications, ANSI/IEEE Std 802.11, 2007 Edition
- 2) M. Benveniste, "QoS in WLANs", in *Emerging Technologies in Wireless LANs: Theory, Design, and Deployment*, (B. Bing, ed.), Cambridge University Press, 2008, ISBN 978-0-521-89584-2
- 3) M. Benveniste, "'Express Forwarding' for Single-Channel Wireless Mesh", IEEE Doc 802.11-07-2452r2.
- 4) M. Benveniste and K. Sinkar, "Performance Evaluation of 'Express Forwarding' for a Single-Channel Mesh", IEEE Doc 802.11-07-2454r1.
- 5) M. Benveniste and K. Sinkar, "More on Performance Evaluation of 'Express Forwarding' for Mesh", IEEE Doc 802.11-08-0142r0.