

# **Tutorial: “Protecting Critical Telecommunications and Networking Infrastructure”**

**The Twelfth International Conference on Networking ICN 2013**

**Drs. Andy Snow\* and Gary Weckman\*\*  
([asnow@ohio.edu](mailto:asnow@ohio.edu) & [weckmang@ohio.edu](mailto:weckmang@ohio.edu))**

**\*School of Information & Telecommunication Systems  
\*\* Department of Industrial & Systems Engineering  
Ohio University**

# Outline

- A. Telecom & Network Infrastructure Risk**
- B. Telecommunications Infrastructure**
- C. RAMS: Reliability, Availability, Maintainability and Survivability**
- D. Protection Level Assessment & Forecasting**

# Outline

- A. Telecom & Network Infrastructure Risk***
- B. Telecommunications Infrastructure**
- C. RAMS: Reliability, Availability, Maintainability and Survivability**
- D. Protection Level Assessment & Forecasting**

# A. Telecom & Network Infrastructure Risk

- Human Perceptions of Risk
- Threats (natural and manmade)
- Vulnerabilities
- Faults Taxonomy
- Service Outages
- Single Points of Failure
- Over-Concentration
- Risk as a  $f(\textit{Severity}, \textit{Likelihood})$
- Protection through fault prevention, tolerance, removal, and forecasting
- Best Practices

# Human Perceptions of Risk

- Perceptions of “Rare Events”
- Users Demand Dependable Systems
- Dependable Systems are Expensive

# Some Fun with Probability

- Which is more likely?
  1. Winning the “Big Lotto”
  2. Getting hit by lightning
  3. Being eviscerated/evaporated by a large asteroid over an 80-year lifetime

# Some Fun with Probability

- Pick one:
  1. Winning the “Big Lotto”
  2. Getting hit by lightning
- *The chances are about the same*
- *One you have to pay for – the other is free*

# Some Fun with Probability

3. Being eviscerated/evaporated by a large asteroid over an 80-year lifetime

– *Based upon empirical data, the chances are about 1 in a million\**

\*A. Snow and D. Straub, “Collateral damage from anticipated or real disasters: skewed perceptions of system and business continuity risk?”, IEEE Engineering Management Conference (IEMC2005), St. Johns, Newfoundland, September 11-14, 2005, pp. 740-744.



# Probability and People

- It is human nature that we perceive “good” events to be more likely and “bad” events to be less likely
- Until a bad event happens, that is

# We Expect Dependability attributes from our Critical Infrastructure

- Reliability
- Maintainability
- Availability
- Survivability<sup>1</sup>
- Data Confidentiality
- Data Integrity

<sup>1</sup>This perspective replaces “Safety” with “Survivability”. Attributes were first suggested in A. Avizienis, et al, “Basic Concepts & Taxonomy of Dependable & Secure Computing”, *IEEE Transactions on Dependable & Secure Computing*, 2004

# We Expect Dependability from our Critical Infrastructure

- Reliability
  - We expect our systems to fail very infrequently
- Maintainability
  - When systems do fail, we expect very quick recovery
- Availability
  - Knowing systems occasionally fail and take finite time to fix, we still expect the services to be ready for use when we need it

# We Expect Dependability from our Critical Infrastructure (Continued)

- Survivability
  - We expect our infrastructure not to fail cataclysmically
  - When major disturbances occur, we still expect organizational missions and critical societal services to still be serviced
- Data Confidentiality
  - We expect data to be accessed only by those who are authorized
- Data Integrity
  - We expect data to be deleted or modified only by those authorized

# Are our Expectations Reasonable?

- Our expectations for dependable ICT systems are high
- So is the cost
- If you demand high dependability.....

# Don't Forget Your Wallet

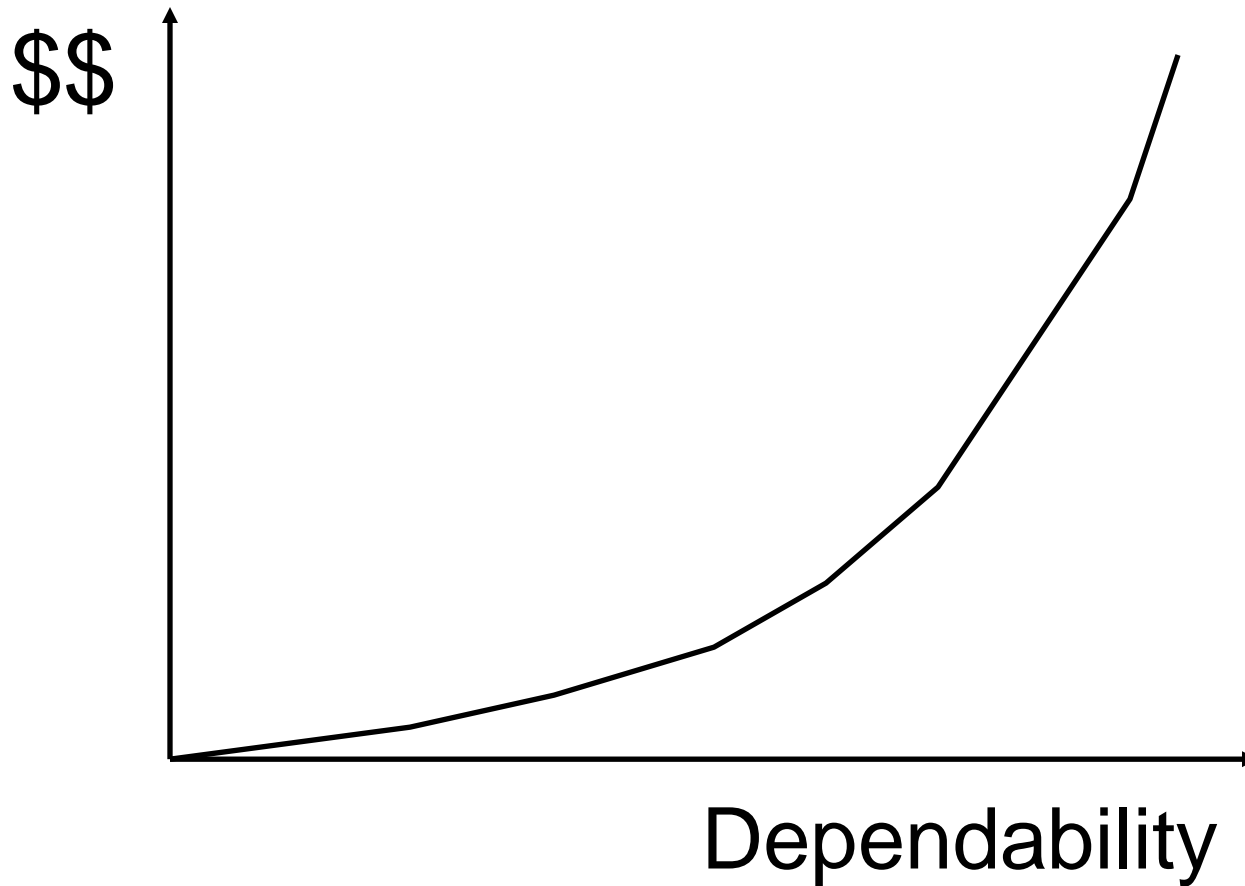

# Focus is often on More Reliable and Maintainable Components

- How to make things more reliable
  - Avoid single points of failure (e.g. over concentration to achieve economies of scale?)
  - Diversity
    - Redundant in-line equipment spares
    - Redundant transmission paths
    - Redundant power sources
- How to make things more maintainable
  - Minimize fault detection, isolation, repair/replacement, and test time
  - Spares, test equipment, alarms, staffing levels, training, best practices, transportation, minimize travel time
- What it takes --- \$

# Paradox

- We are fickle
- When ICT works, no one wants to spend \$\$ for unlikely events
- When an unlikely event occurs
  - We wish we had spent more
- Our perceptions of risk before and after catastrophes are key to societal behavior when it comes to ICT dependability



# Fukushima Nuclear Accident

- Nuclear reactor cooling design required AC power
- Power Redundancy
  - Two sources of commercial power
  - Backup generators
  - Contingency plan if generators fail? Fly in portable generators
- Risks?
  - Power plant on coast a few meters above sea-level
  - Tsunamis: a 5 meter wall

# Fukushima Nuclear Accident (Continued)

- Design vulnerabilities?
  - Nuclear plant **requires AC Power for cooling**
  - **Tsunami wall 5 meters high**, in a country where in the last 100 years numerous > 5 meter tsunamis occurred
  - Remarkably, **backup generators at ground level** (not on roofs !!! )
- Where do tsunamis come from?
  - Ocean floor earthquakes
- What can a severe land-based earthquake do?
  - Make man-made things fall, such as AC power lines

# Sequence of Events: Fukushima Nuclear Accident

1. Large land based and ocean floor earthquake
  - AC transmission lines fall
  - Ten meter tsunami hits Fukushima
2. Backup Generators
  - Startup successfully, then
  - Flooded by tsunami coming over wall
3. Portable generators
  - Flown in
  - Junction box vault flooded
4. Nuclear reactors overheat, go critical, and explode

**For 40 years, people walked by AC generators at ground level and a 5 meter tsunami wall !!!!**

# 9-11 Effect

## Geographic Dispersal of Human and ITC Assets

# Pre 9-11 IT Redundancy

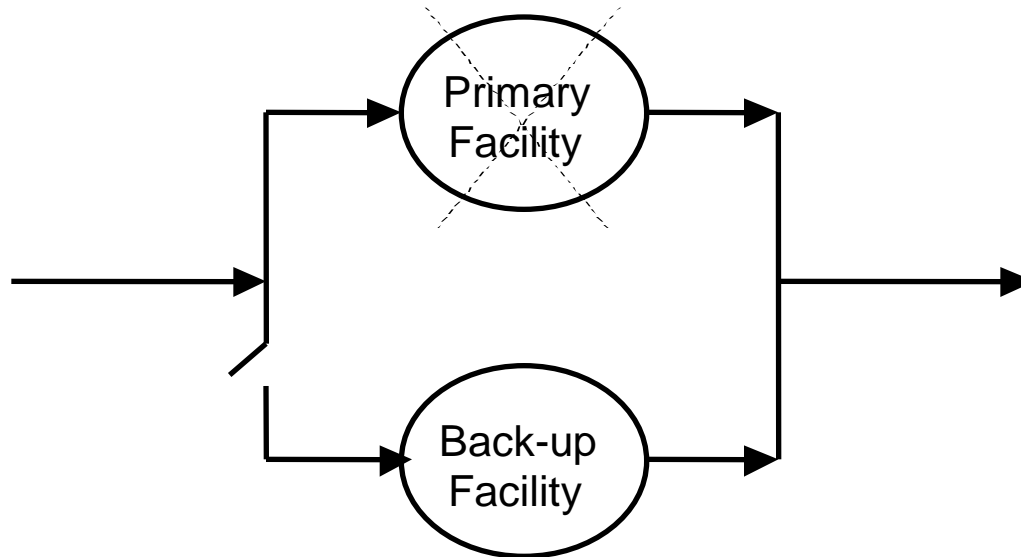

<b>Scenario</b>	<b>Single IT Facility Reliability</b>	<b>Redundant IT Facility Reliability</b>
1	0.90	0.9900
2	0.95	0.9950
3	0.99	0.9999

# Key Assumptions

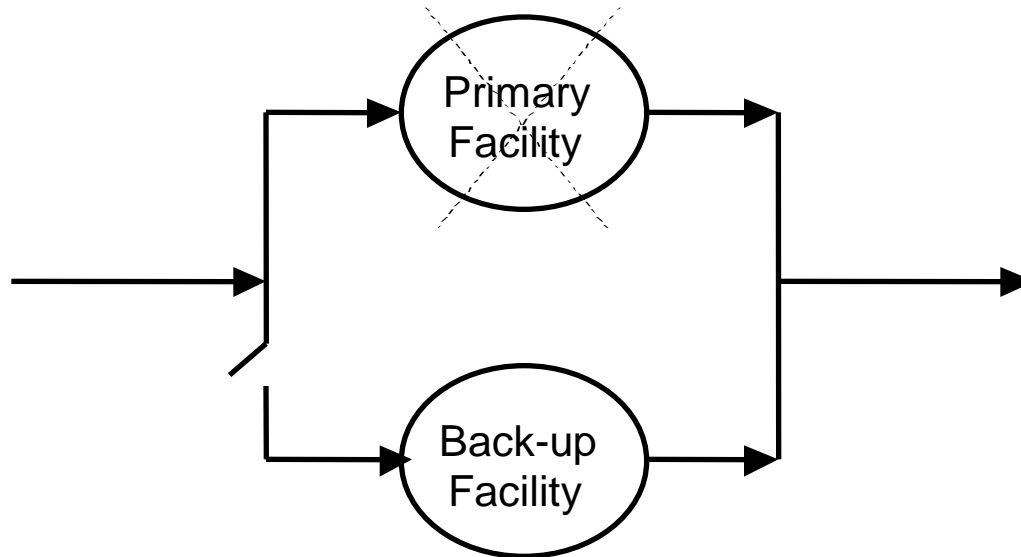

1. Failures are independent
2. Switchover capability is perfect

# 9-11: Some Organizations Violated These Assumptions

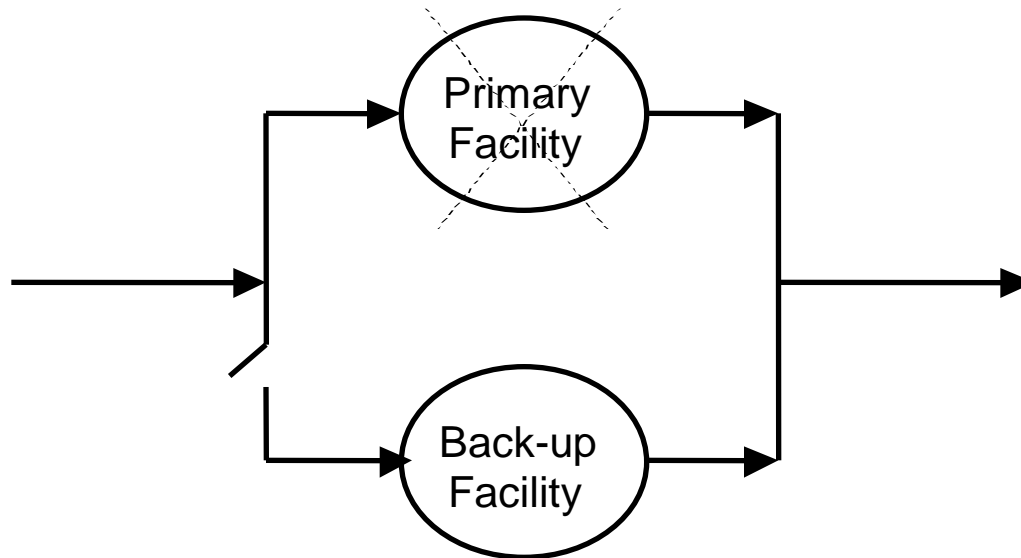

1. Failures not independent
  - Primary in WTC1
  - Backup in WTC1 or WTC2
2. Switchover capability disrupted
  - People injured or killed in WTC expected to staff backup facility elsewhere
  - Transportation and access problems

# Post 9-11 IT Redundancy Perspectives

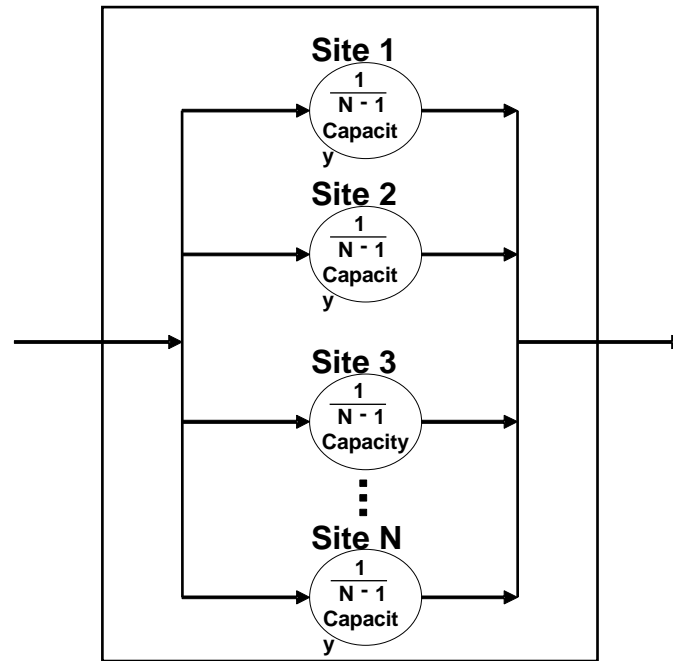

- No concentrations of people or systems to one large site
- Geographically dispersed human and IT infrastructure
- Geographic dispersal requires highly dependable networks
- Architecture possible with cloud computing !!



# Geographic Dispersal

- A. Snow, D. Straub, R. Baskerville, C. Stucke, “The survivability principle: it-enabled dispersal of organizational capital”, in Enterprise Information Systems Assurance and System Security: Managerial and Technical Issues, Chapter 11, Idea Group Publishing, Hershey, PA, 2006.
- Now commonplace technique with cloud computing !!

# Challenges in Ensuring Adequate Telecom Critical Infrastructure Protection (CIP)

- Communication Infrastructure Convergence
- Communication Industry Sector Consolidations
- Intra- and Inter - Sector Dependence
- High CIP Levels = = \$\$\$\$
- Assessing Risk is difficult
- Vulnerability Dilemma: Secrecy vs. Sunshine
- Varying National/Regional Regulatory Authority and Priorities
- National Preemptions

# Convergence, Consolidation and Interdependence

- The outages of yester-year affected voice, data OR video
- The outages of today and tomorrow affect all three.
  - Technological convergence
  - Telecom mergers and acquisitions
- Inter-sector dependence
  - Geographic overlay of telecom, natural gas, electricity, and water?
  - Telecom needs power.....power needs telecom
  - SCADA separate from IT?

# High CIP Levels = = \$\$\$\$

- Who Pays??
- Regulatory Regime: Unregulated vs. Price Cap vs. Rate-of-Return (RoR)
- Competitive vs. Noncompetitive markets
- Service Provider Economic Equilibrium Points
  - Economies of Scale vs. Vulnerability Creation
  - Proactive vs. Reactive Restoration Strategies
  - Geography: Urban vs Rural

# Assessing Risk is Difficult

- Severity
  - Safety impact
  - Economic impact
  - Geographic impact
- Likelihood
  - Vulnerabilities
  - Means and Capabilities
  - Motivations

# CIP Vulnerability Dilemma: Secrecy vs. Sunshine

- Market correction of vulnerabilities vs. Exposing CIP to exploitation
- Known vs. Unknown vulnerabilities
- Customer knowledge of service provider vulnerabilities?
- Data sharing
  - National, Regional, State, County, Municipal
- Tracking outages as a bellwether for CIP
  - Establishing measures and reporting thresholds
- Tracking frequency, size, duration of events

# Infrastructure Protection and Risk

- Outages
- Severity
- Likelihood
- Fault Prevention, Tolerance, Removal and Forecasting

# Infrastructure Protection and Risk

- Outages
  - Severity
  - Likelihood
  - Fault Prevention, Tolerance, Removal and Forecasting
- } RISK



# Risk

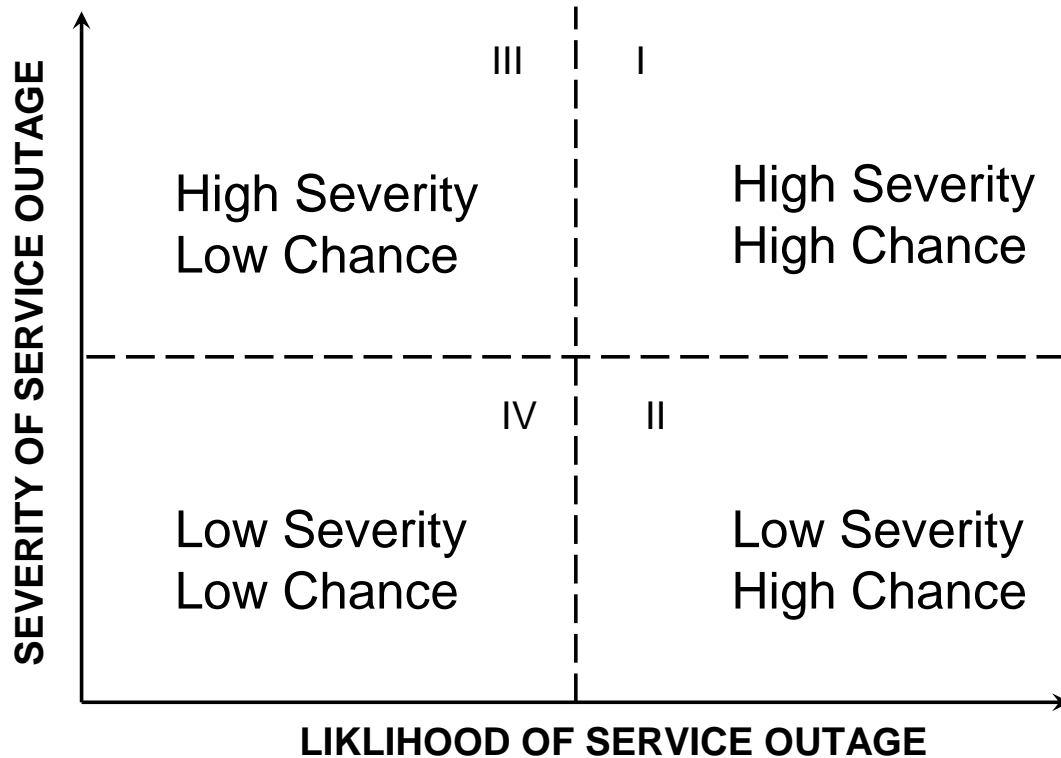

# Vulnerabilities and Threats

- *Vulnerability* is a weakness or a state of susceptibility which opens up the infrastructure to a possible outage due to attack or circumstance.
- The cause of a vulnerability, or error state, is a *system fault*.
- The potential for a vulnerability to be exploited or triggered into a disruptive event is a *threat*.
- Vulnerabilities, or faults, can be exploited intentionally or triggered unintentionally

# Proactive Fault Management

- Fault Prevention by using design, implementation, and operations rules such as standards and *industry best practices*
- Fault Tolerance techniques are employed, wherein equipment/process failures do not result in service outages because of fast switchover to equipment/process redundancy
- Fault Removal through identifying faults introduced during design, implementation or operations and taking remediation action.
- Fault Forecasting where the telecommunication system fault behavior is monitored from a quantitative and qualitative perspective and the impact on service continuity assessed.

# Telecommunication Infrastructure Threats and Vulnerabilities

- Natural Threats
  - Water damage
  - Fire damage
  - Wind damage
  - Power Loss
  - Earthquake damage
  - Volcanic eruption damage
- Human Threats
  - Introducing or triggering vulnerabilities
  - Exploiting vulnerabilities (hackers/crackers, malware introduction)
  - Physical Vandalism
  - Terrorism and Acts of War
- Fault Taxonomy

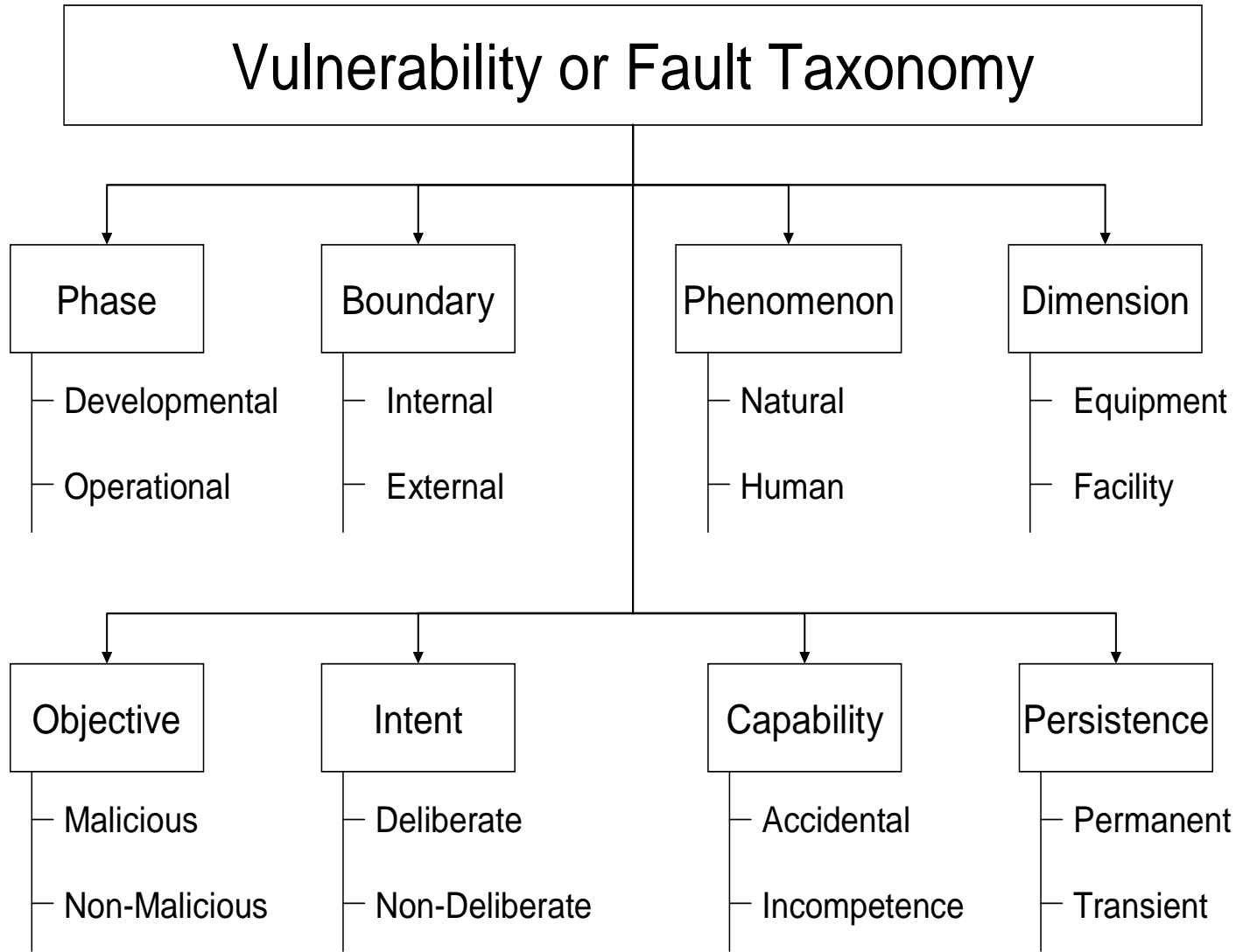

# Reference

- A. Avizienis, et al, “Basic Concepts & Taxonomy of Dependable & Secure Computing”, *IEEE Transactions on Dependable & Secure Computing*, 2004.

# Case Study – Danger Index

- **Snow, Weckman & Hoag, “Understanding Danger to Critical Telecom Infrastructure: A Risky Business”, *International Conference on Networks 2009 (ICN09)*, IEEE Communications Society Press, March 2009.**

# Danger

- Malicious acts aimed directly against humans, or indirectly at their critical infrastructures is a real and present danger
- However, most compromises to TCOM critical infrastructure are often accidental and non-malicious
- How can we quantify the danger??
  - Not easily



# September 11, 2001

- A large telecommunications outage resulted from the collapse of the world trade centers
  - Over 4,000,000 data circuits disrupted
  - Over 400,000 local switch lines out
- Pathology of the event
  - Towers collapsed
  - Some physical damage to adjacent TCOM building
  - Water pipes burst, and in turn disrupted TCOM facility power and power backup facilities
- What was the a priori probability of such an event and ensuing sequence?
  - $P = \Pr\{\text{Successful hijack}\} \times \Pr\{\text{Building Collapse}\} \times \Pr\{\text{Water Damage}\}$
  - Infinitesimal??

# Probabilities

- Risk assessments requiring “probabilities” have little utility for rare events
- Why? Can’t rationally assess probability
- Such probabilistic analysis attempts may also diminish focus of the root cause of the outage, and may detract from remediating vulnerabilities
- In the 9-11 case the issue was one of TCOM “over-concentration” or creation of a large SPF

# Quantifying Danger

- Randell Larson, *Our Own Worst Enemy: Asking the Right Questions About Security to Protect You, Your Family, and America*. Grand Central Publishing (September 7, 2007).
- “Danger Index” proposed by Larsen
- $Danger = Intention \times Capability \times Vulnerability \times Consequence$
- Four variables, each with range [1,10]
- Danger Index range [1, 10000]

# “Danger” Different from “Risk”?

*Danger = Intention x Capability x Vulnerability x Consequence*

*Risk = Likelihood x Severity*

# “Danger” Different from “Risk”?

*Danger = Intention x Capability x Vulnerability x Consequence*

*Risk = Likelihood x Severity*

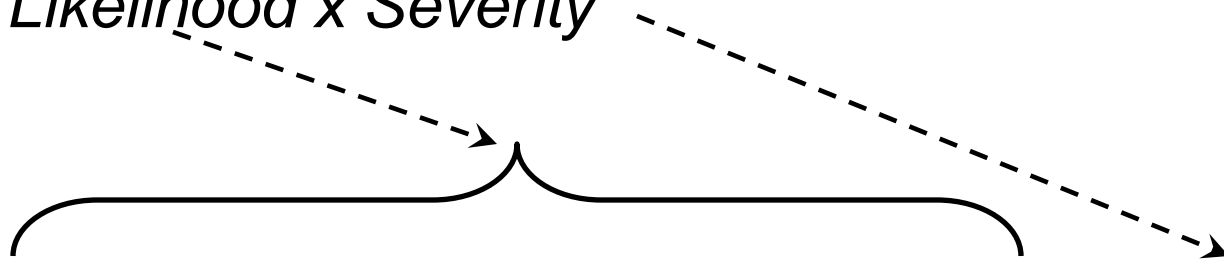

*Risk = (Intention x Capability x Vulnerability) x Consequence*

# “Danger” Different from “Risk”?

*Danger = Intention x Capability x Vulnerability x Consequence*

*Risk = Likelihood x Severity*

*Risk = (Intention x Capability x Vulnerability) x Consequence*

*Risk = Threat x Vulnerability x Severity*

# Danger Index and Risk

- Conclusion?
  - Danger Index a proxy for Risk
- Question
  - Does Danger Index present an “easy and useful” way to assess TCOM risk?

# We Will Look at Some Outage Pathologies Later

- Power
- SS7 A-Link Deployment
- Network asset concentration
- Fault Tolerant Rings
- PCS Wireless Architecture



# Typical TCOM Power

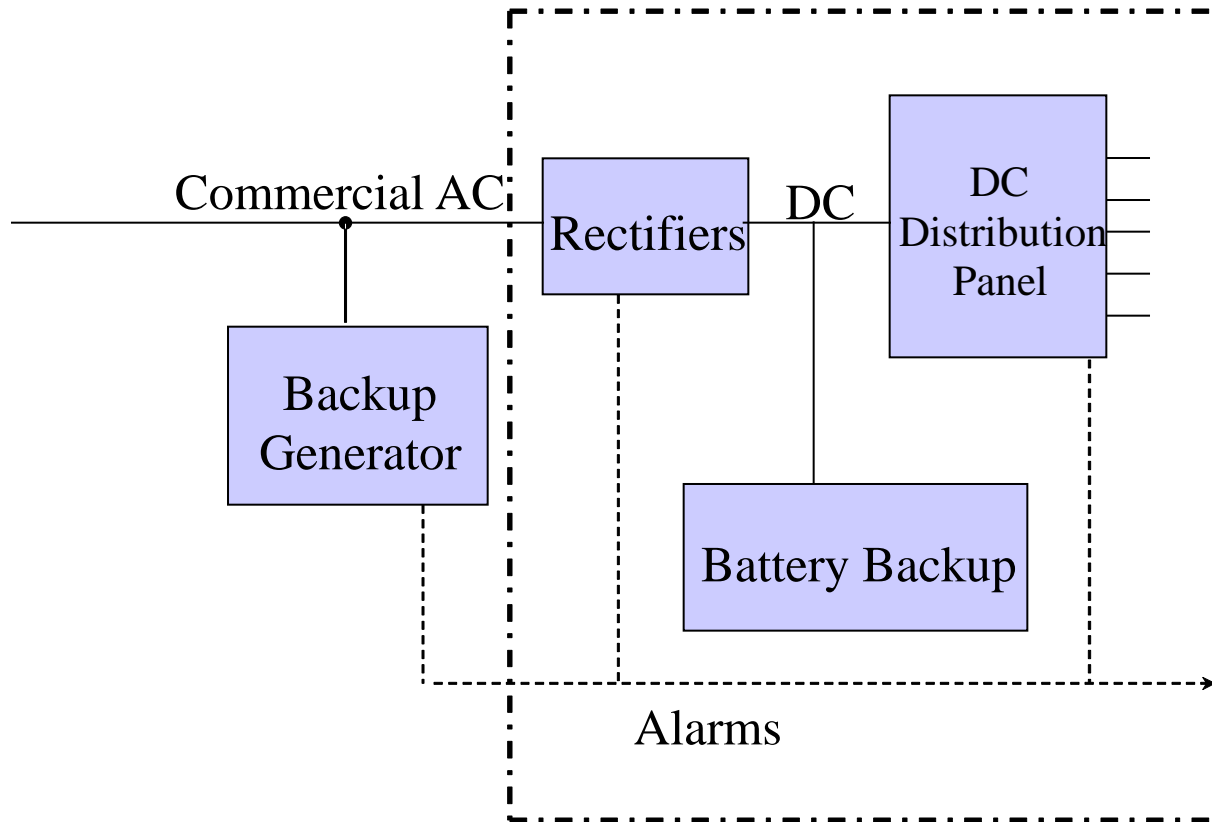

# PCS Architecture

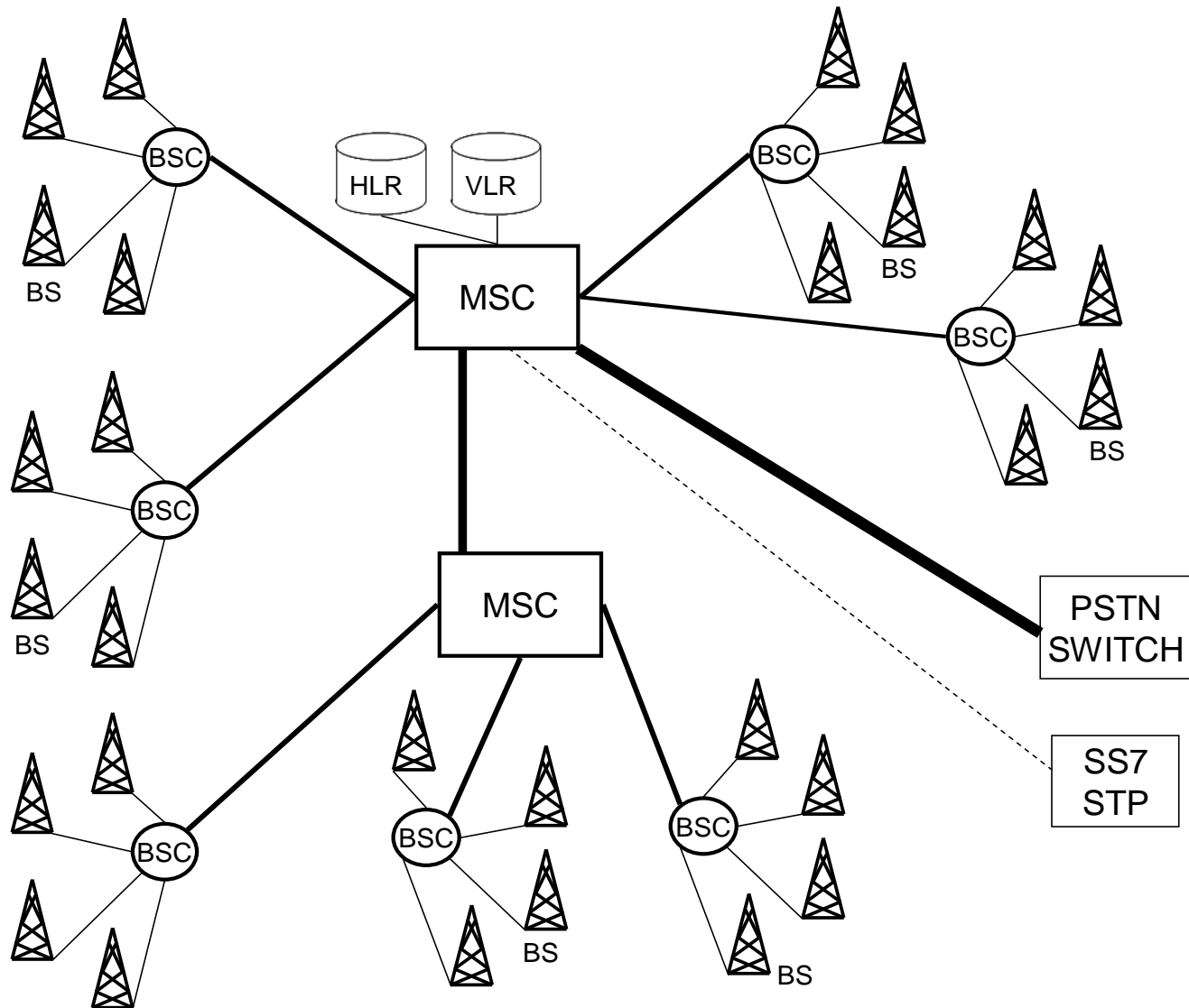

# Some Conclusions about Vulnerability

- Vulnerability highly situational, facility by facility
- But a qualitative judgment can select a quantitative score [1, 10]

# Danger Index Applied to Networks

- Consequence
  - Size of outage, economic impact
- Vulnerability
  - weakness or a state of susceptibility which opens up the infrastructure to a possible outage due to attack or circumstance
- Intention
  - Benign (installation, operations and maintenance)
  - Malicious (intentional, high enough value of target)
- Capability
  - Skill of exploiting or triggering personnel
  - Knowledge of vulnerability
  - Tools, devices to exploit or trigger vulnerability into a disruptive event

# PCS Base Station

	Base Station	Comments
Consequence	2	Up to 2,000 users impacted
Vulnerability	10	Tower highly visible with fence around small footprint
Intention	3	Value of target low to terrorist, but susceptible to vandals
Capability	10	Explosive or quick entry possible
Danger Index	600	6% if normalized to 100%

# PCS Mobile Switching Center

	MSC	Comments
Consequence	8	Up to 100,000 users impacted
Vulnerability	4	Building not too obvious, with decent physical security and alarms
Intention	3	Value of target moderate to terrorists, hard for vandals
Capability	7	Susceptible to car bomb
Danger Index	672	6.7% normalized to 100%

# SONET Ring

	SONET Ring	Comments
Consequence	9	Hundreds of thousands or more impacted
Vulnerability	2	Fault tolerant ring. Requires (1) two fiber cuts, (2) one fiber cut and node failure, or (3) two node failures for outage. Ring in MAN, not WAN; requires good O&M to replace/repair if ring goes to protect mode
Intention	4	Value of target moderate to high for terrorists, vandals or thief's might mistake for copper
Capability	2	Hard to locate fiber, nodes in buildings
Danger Index	144	1.4% normalized to 100%

# Danger Index

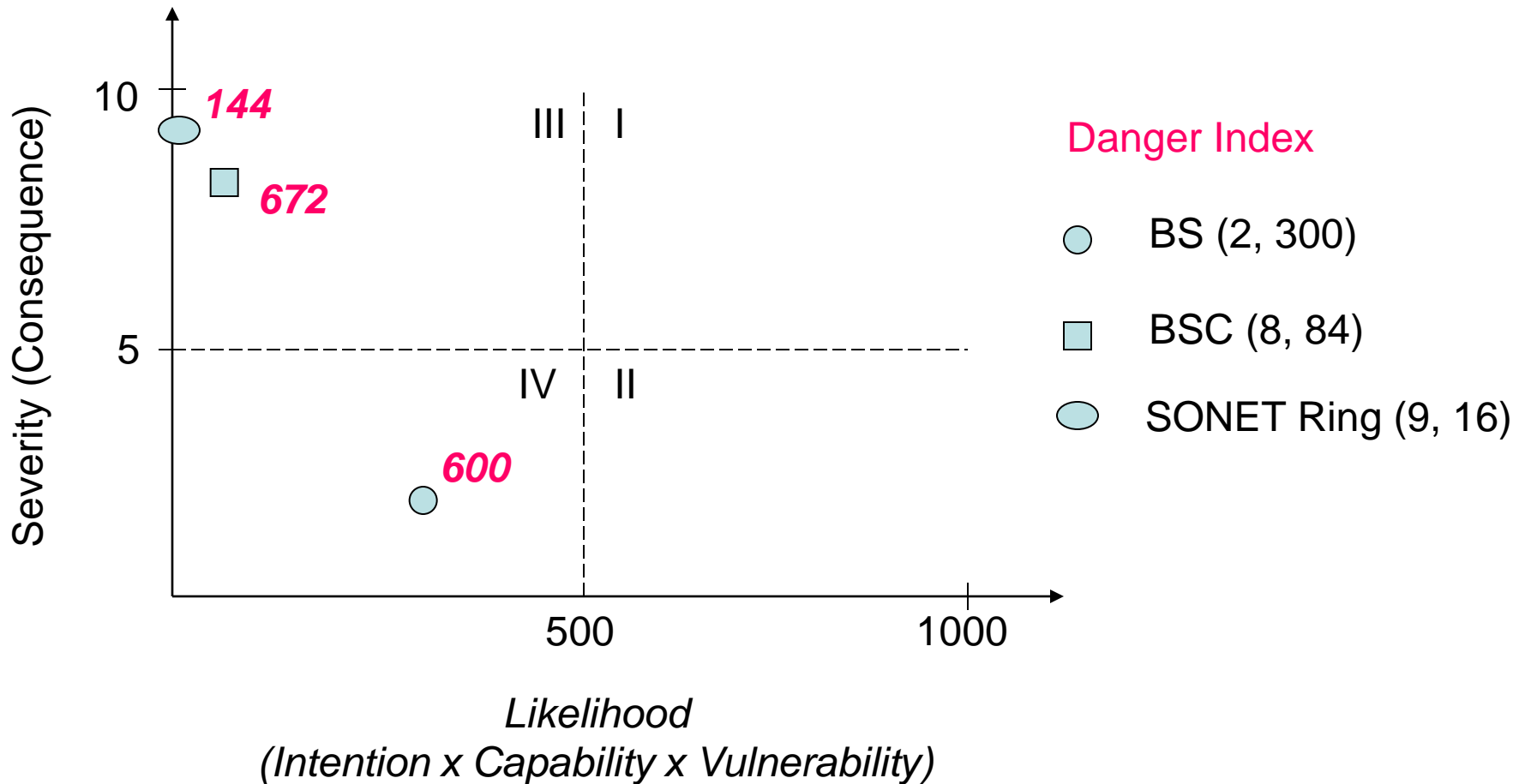



# Conclusion Regarding Danger Index

- Highly situational, facility by facility
  - Engineering, installation, operations, and maintenance
  - Security (physical, logical layers, etc)
  - Degree of adherence to best practices, such as NRIC
- Need rules and consistency for assigning [1, 10] scores in the four dimensions
- A normalized danger index looks feasible, practical and useful for TCOM risk assessments
- Avoids guesses at probabilities
- Allows prioritization to ameliorate risk

# Outline

- A. Telecom & Network Infrastructure Risk**
- B. Telecommunications Infrastructure***
- C. RAMS: Reliability, Availability, Maintainability and Survivability**
- D. Protection Level Assessment & Forecasting**

## B. Telecommunications Infrastructure

- Wireline architecture and vulnerabilities
- Wireless architecture and vulnerabilities
- Cable architecture and vulnerabilities

# Public Switched Telephone Network

- Architecture
- Local and Tandem Switching
- Transmission
- Signaling & SS7
- Power
- Vulnerabilities

# PSTN Architecture

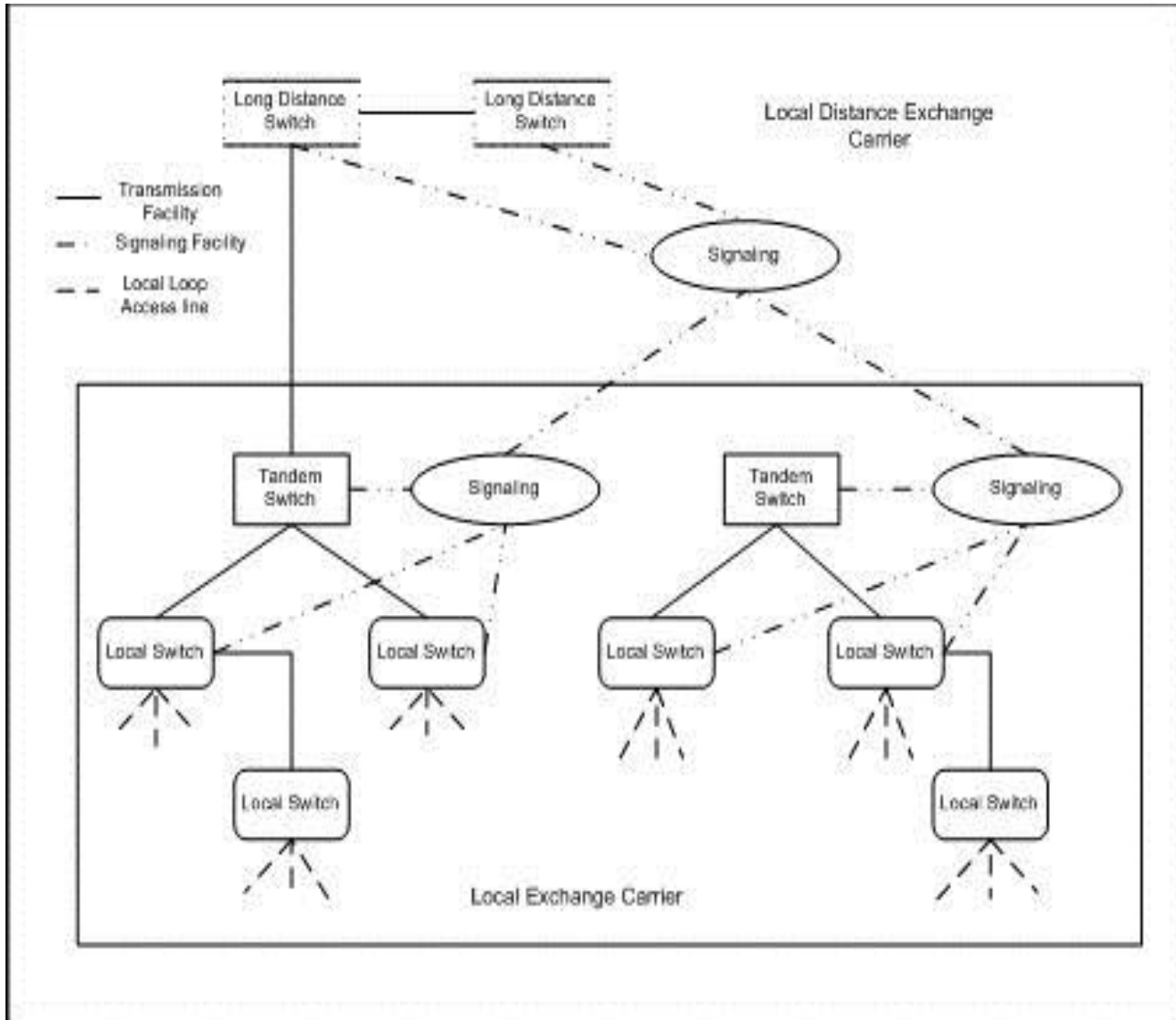

# PSTN End to End Connections

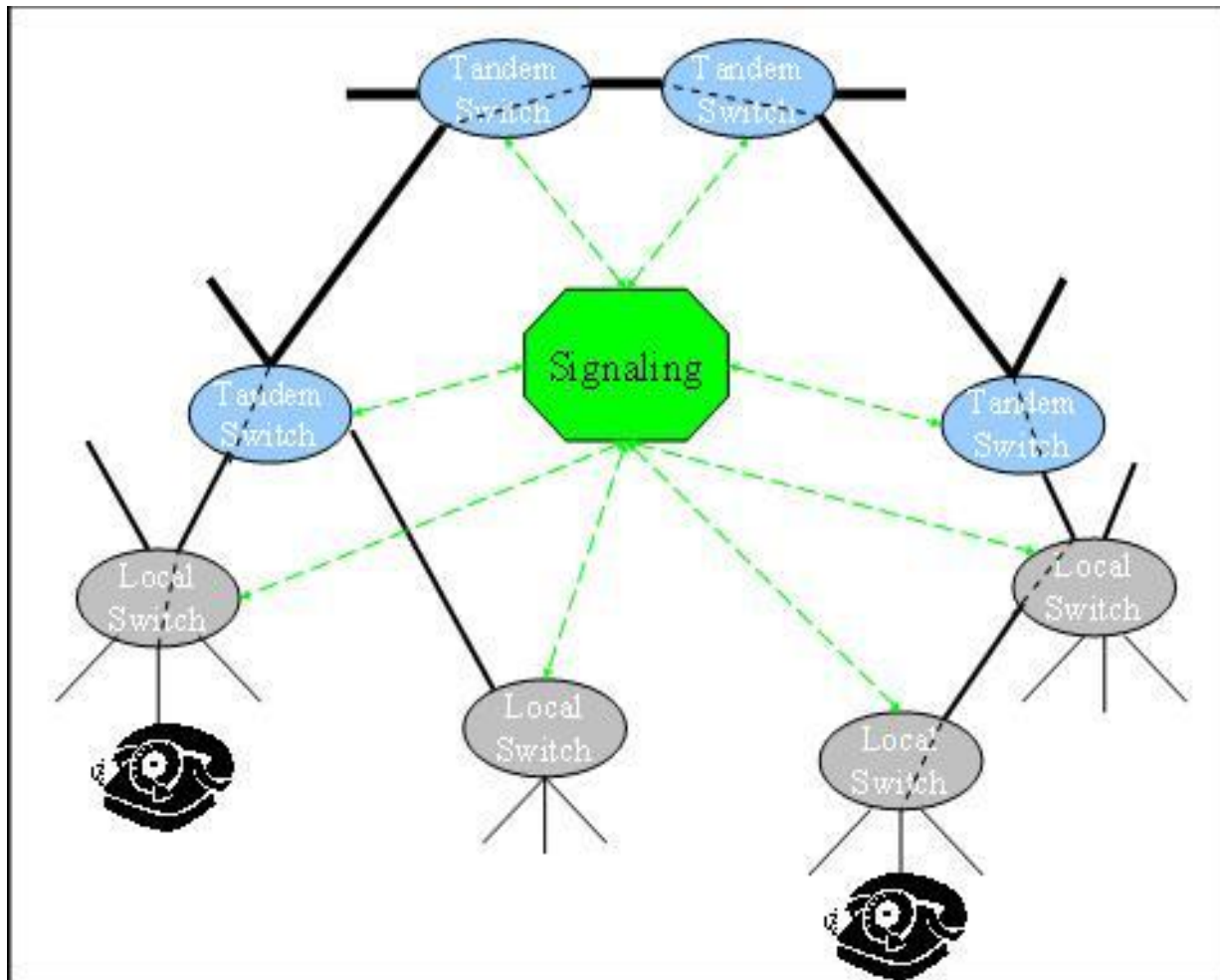

# Infrastructure Census

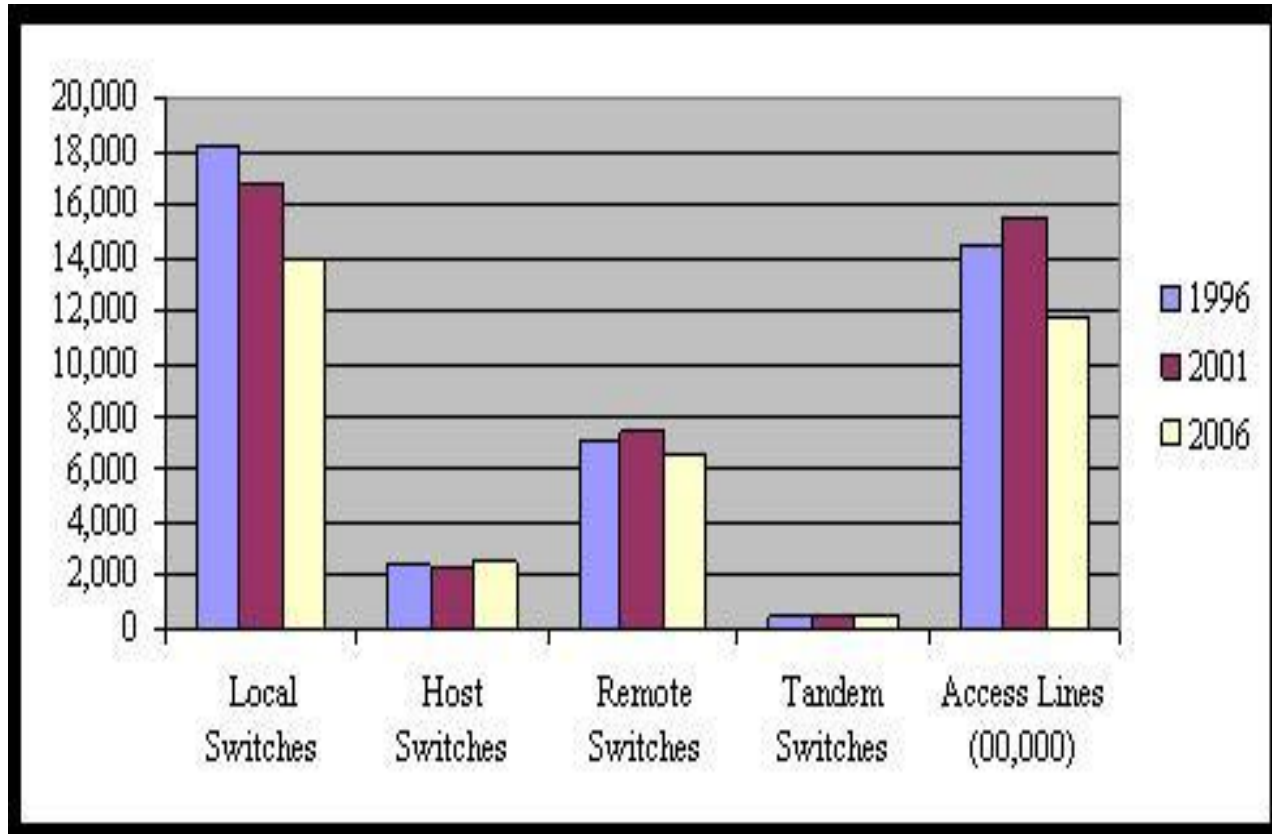

Source: [www.fcc.gov](http://www.fcc.gov) ARMIS  
Copyright 2008-13 Andrew Snow  
All Rights Reserved

# Switching Infrastructure Dispersal/Concentration

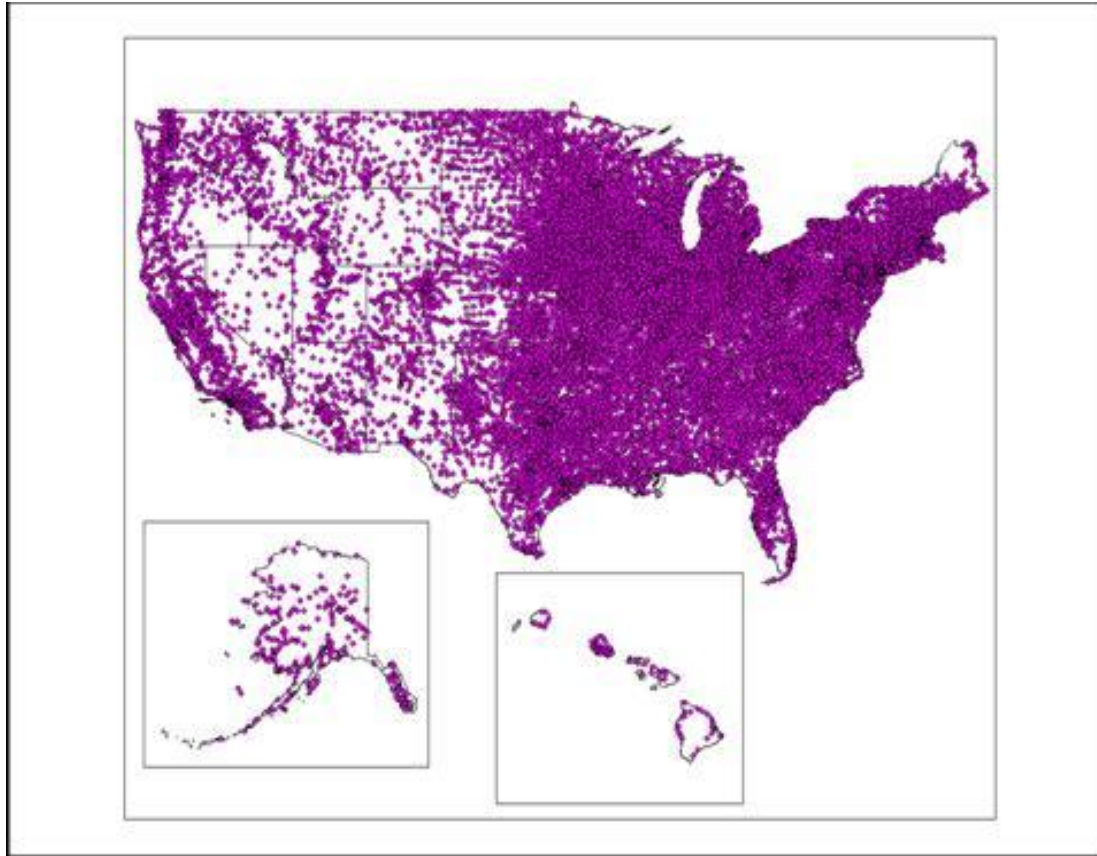

Retrieved from Wikipedia November 7, 2007.

[http://en.wikipedia.org/wiki/Image:Central\\_Office\\_Locations.png](http://en.wikipedia.org/wiki/Image:Central_Office_Locations.png)



# US Growth in Fiber & High Speed Digital Circuits to Customer Premises

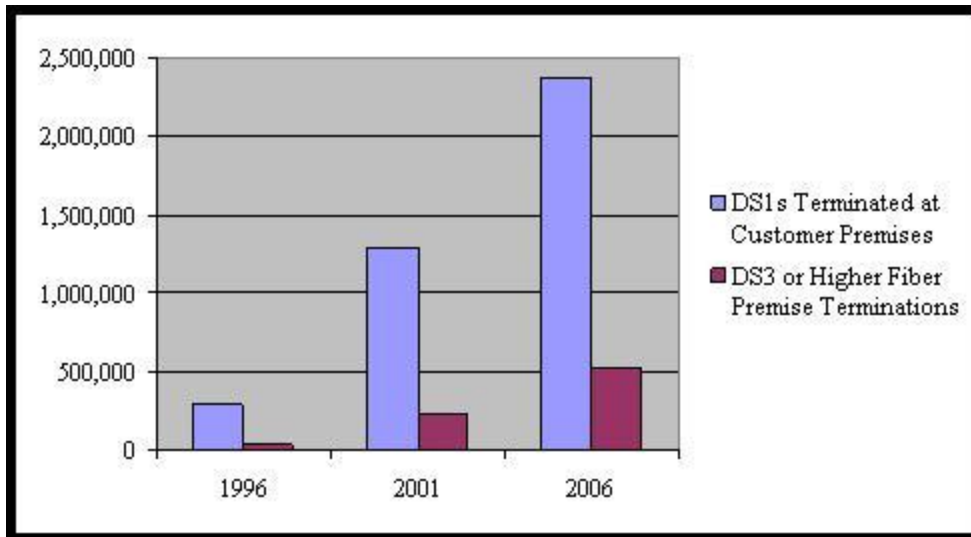
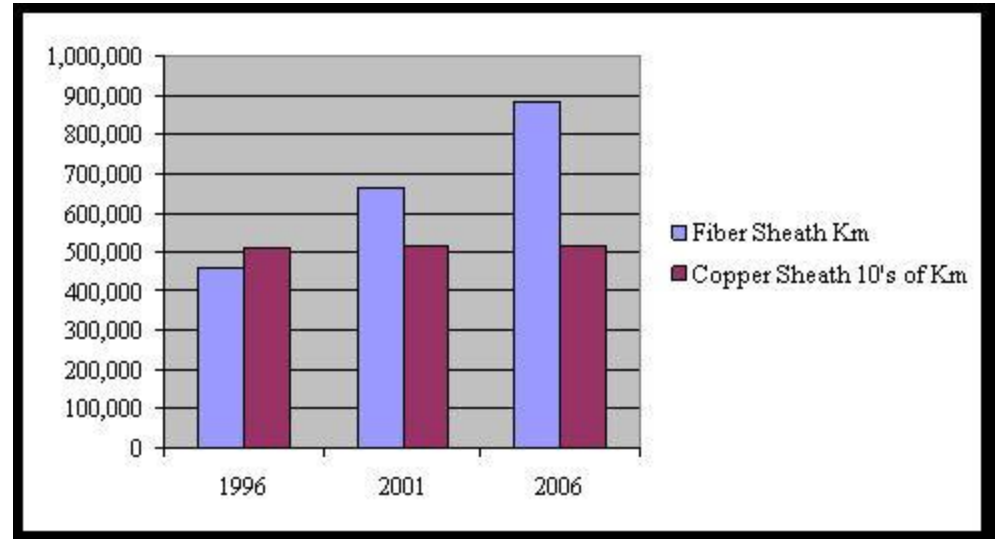

# Transmission Vulnerabilities

- Fiber cuts with non-protected transmission systems
- Fiber over Bridges
- Fiber transmission failures inside carrier facilities
- Digital Cross Connect Systems
- Local Loop Cable Failures

# Transmission Vulnerabilities

- Fiber cuts with non-protected transmission systems:
  - No backup path/circuits deployed.
  - Often done for economic reasons
  - In urban areas where duct space is at a premium
  - In rural areas where large distances are involved.
- Fiber over Bridges:
  - Fiber is vulnerable when it traverses bridges to overcome physical obstacles such as water or canyons
  - There have been reported instances of fires damaging cables at these points

# Transmission Vulnerabilities

- Fiber transmission failures inside carrier facilities:
  - Studies by FCC staff and other researchers have demonstrated that the majority of fiber transmission problems actually occur inside carrier facilities
  - Caused by installation, and maintenance activities.
- Digital Cross Connect Systems:
  - Although hot standby protected equipment, DACSs have failed taking down primary and alternate transmission paths.
  - These devices represent large impact SPFs.
- Local Loop Cable Failures:
  - In some instances, construction has severed multipair cable, or cable sheaths have become flooded
  - Require long duration splicing or replacement

# Proper SONET Ring Operation

 Means same fiber,  
cable, duct, or conduit

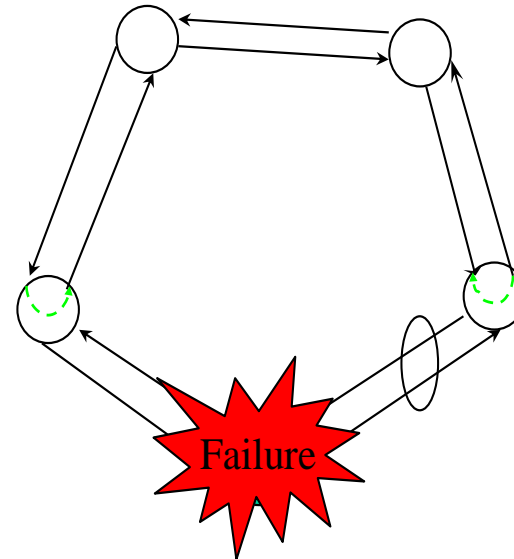
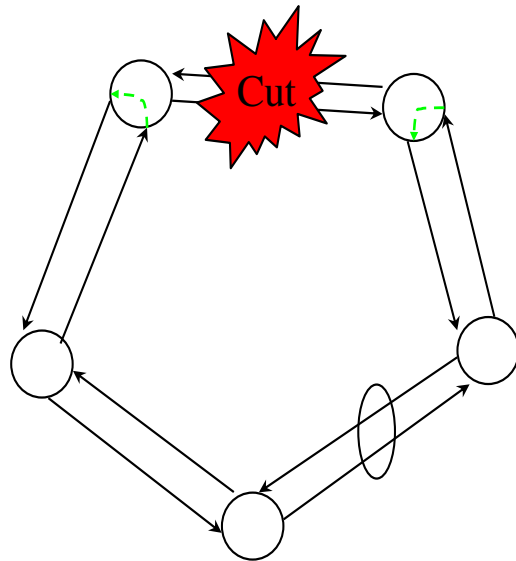

# Improper Operation of SONET Rings

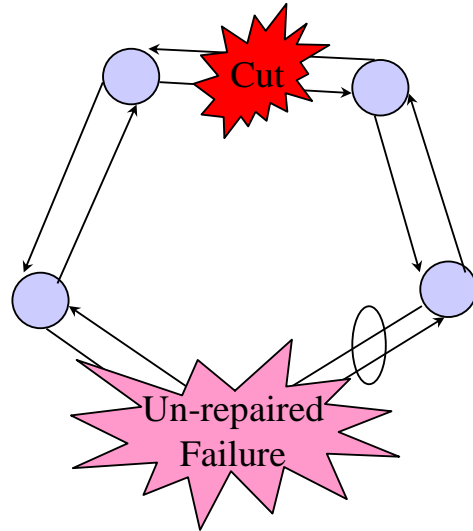

Improper Maintenance:  
Node's previous failure,  
and subsequent fiber cut  
prior to spare on hand

○ Means same fiber,  
cable, duct, or conduit

Improper Deployment:  
"Collapsed" or "Folded" Ring  
sharing same path or conduit

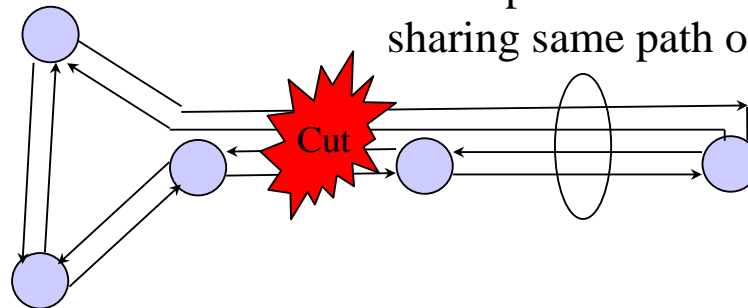

# Outside Plant Vulnerable Near Central Offices

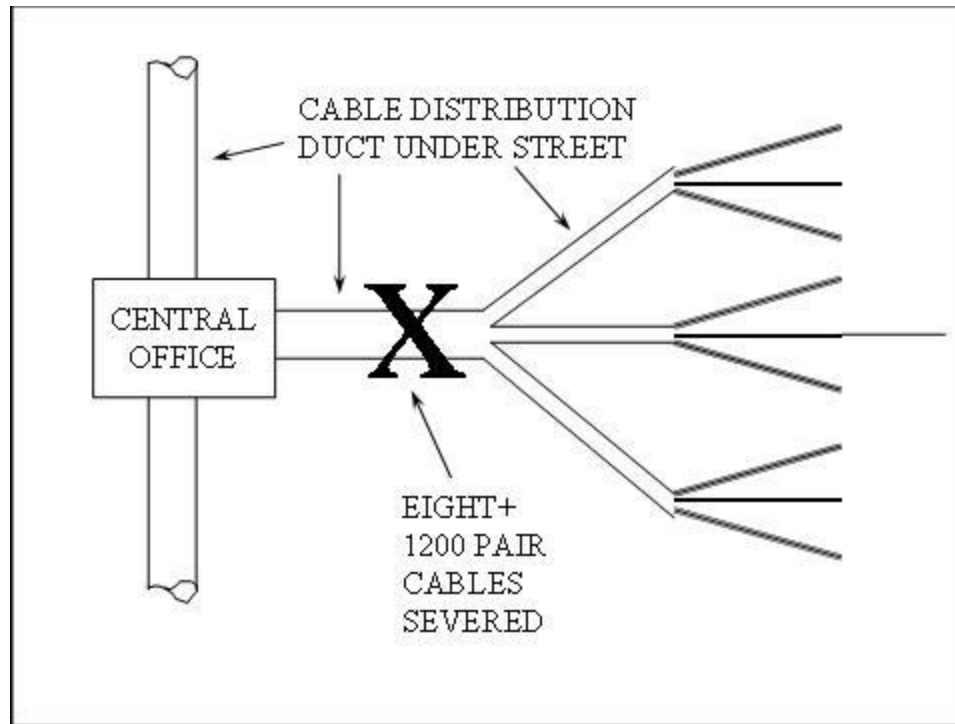

# SS7 Architecture

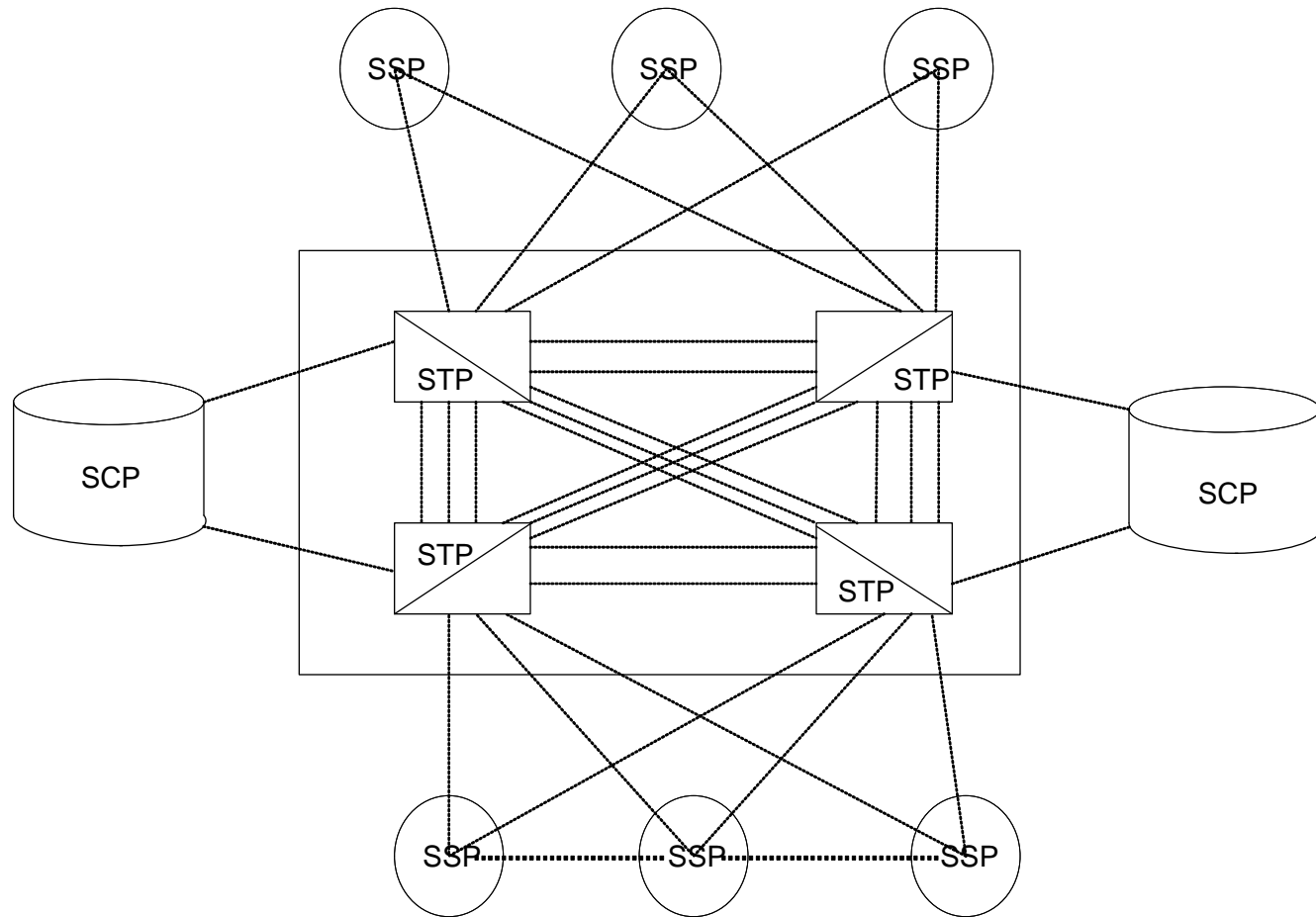

- A, B, or C, or F Transmission Link
- SSP: Signaling Service Point (Local or Tandem Switch)
- STP: Signal Transfer Point (packet Switch Router)
- SCP: Service Control Point



# SS7 Vulnerabilities

- Lack of A-link path diversity: Links share a portion or a complete path
- Lack of A-link transmission facility diversity: A-links share the same high speed digital circuit, such as a DS3
- Lack of A-link power diversity: A-links are separate transmission facilities, but share the same DC power circuit
- Lack of timing redundancy: A-links are digital circuits that require external timing. This should be accomplished by redundant timing sources.
- Commingling SS7 link transmission with voice trunks and/or alarm circuits: It is not always possible to allocate trunks, alarms and A-links to separate transmission facilities.

# SS7 A-Links

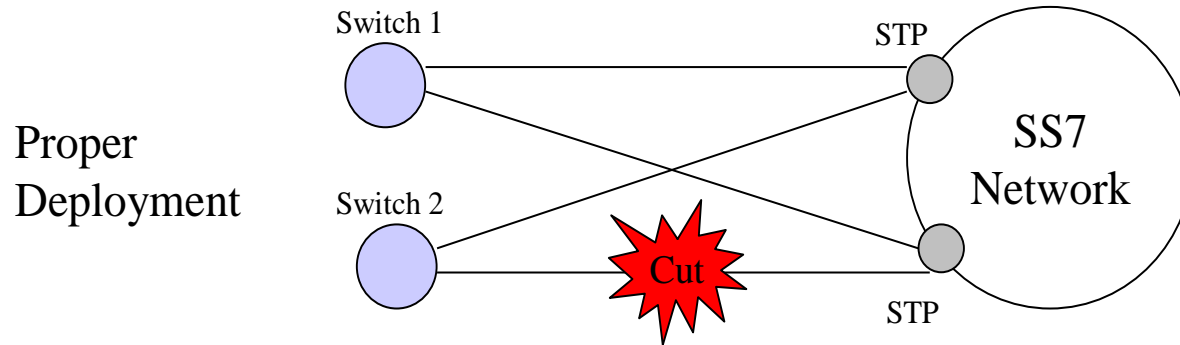

○ Means same fiber, cable, duct, or conduit

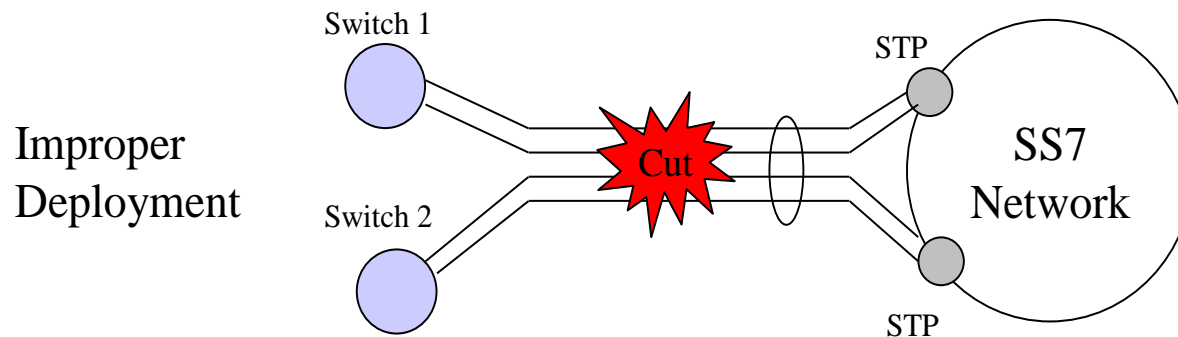

# SS7 A-Links

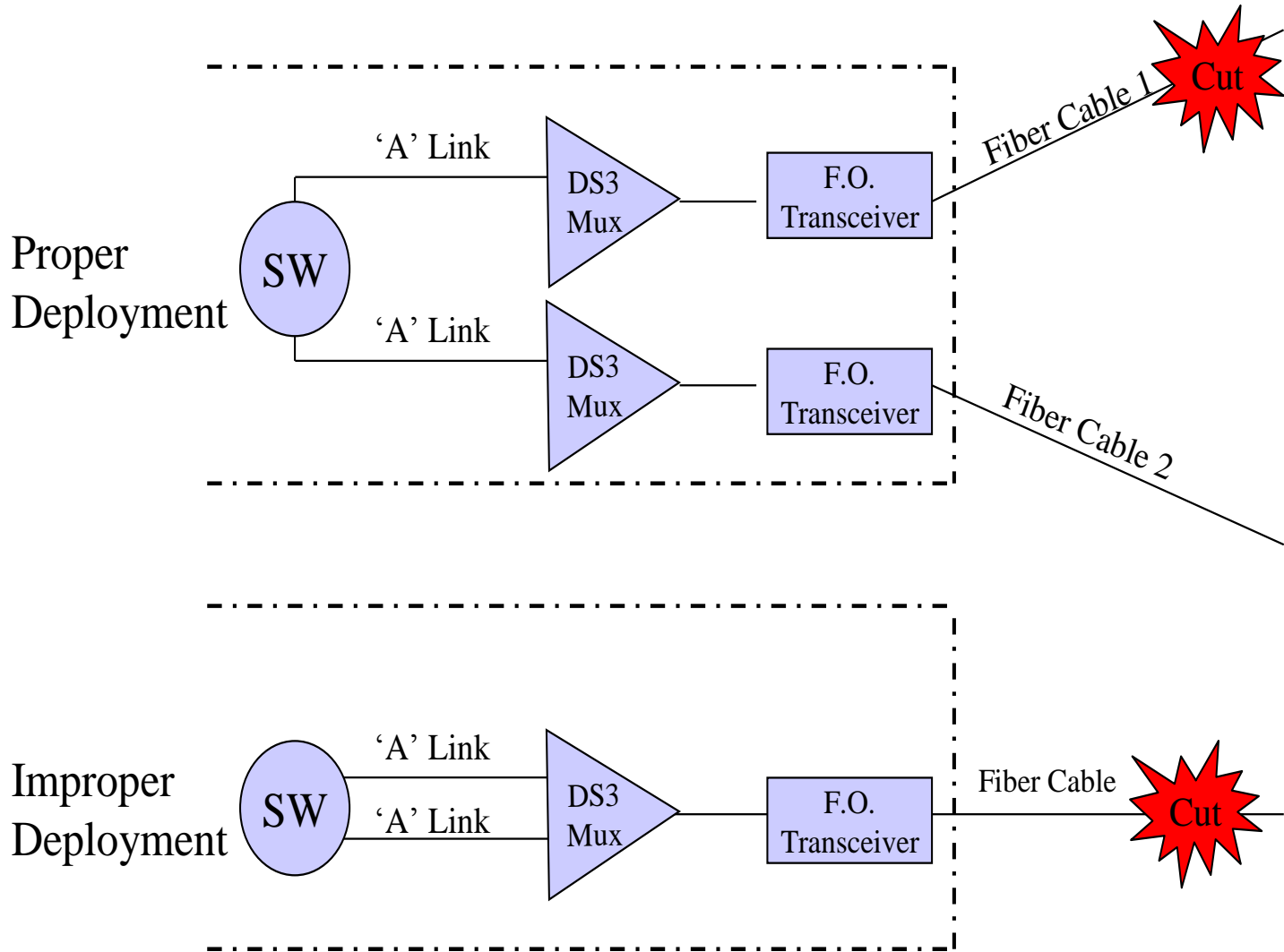

# SS7 A-Links

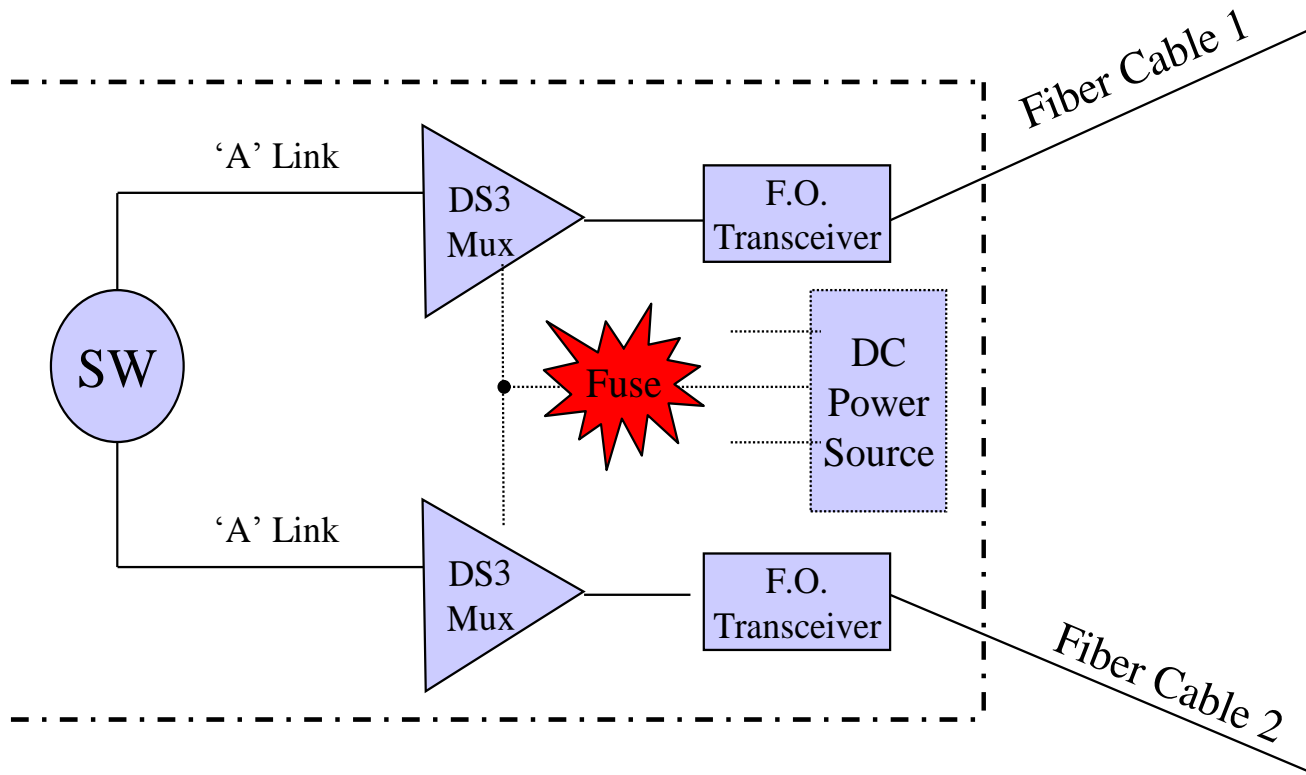

# Power Architecture & Vulnerabilities

- Triply Redundant Power
  - Commercial AC
  - AC Generator
  - Batteries

# Inoperative Alarms

- Loss of commercial power
- Damaged generator
- Untested or inoperable alarms prior to loss and damage
- Batteries Deplete

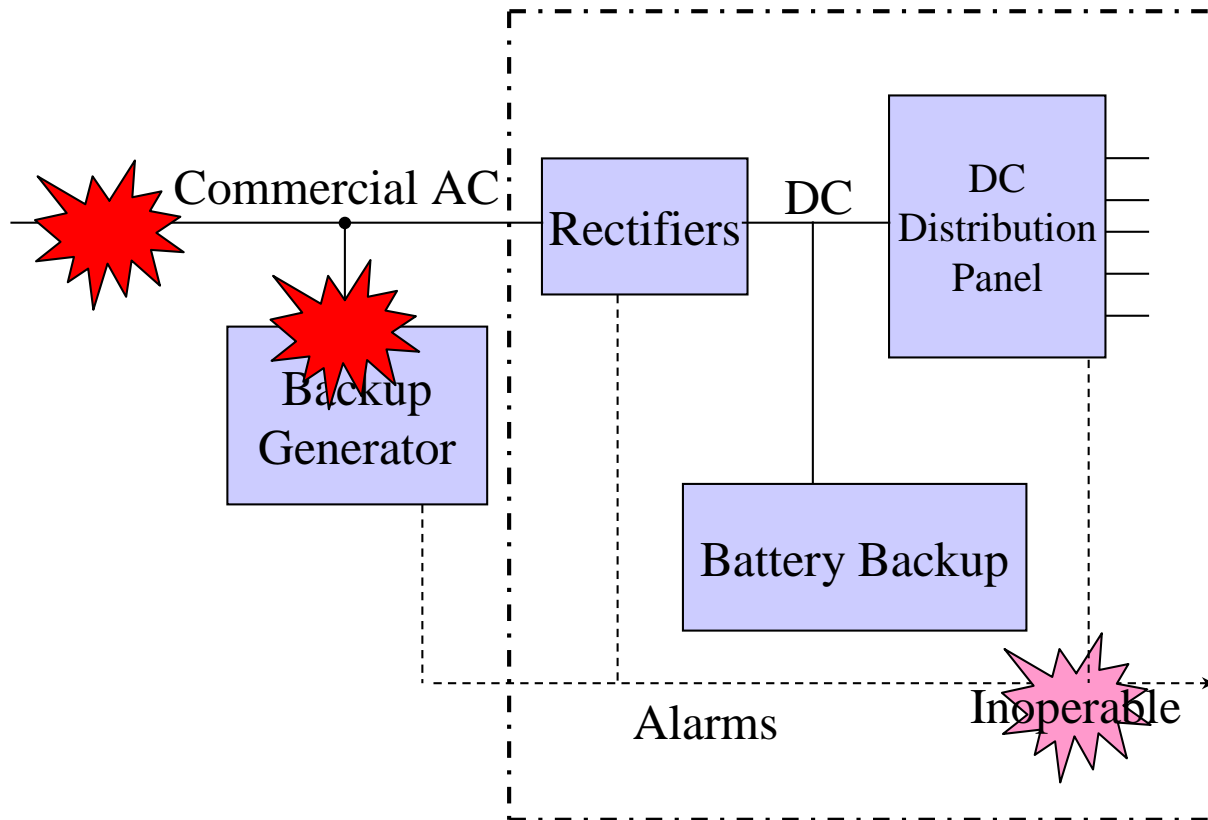

# Economy of Scale Over-Concentration Vulnerabilities

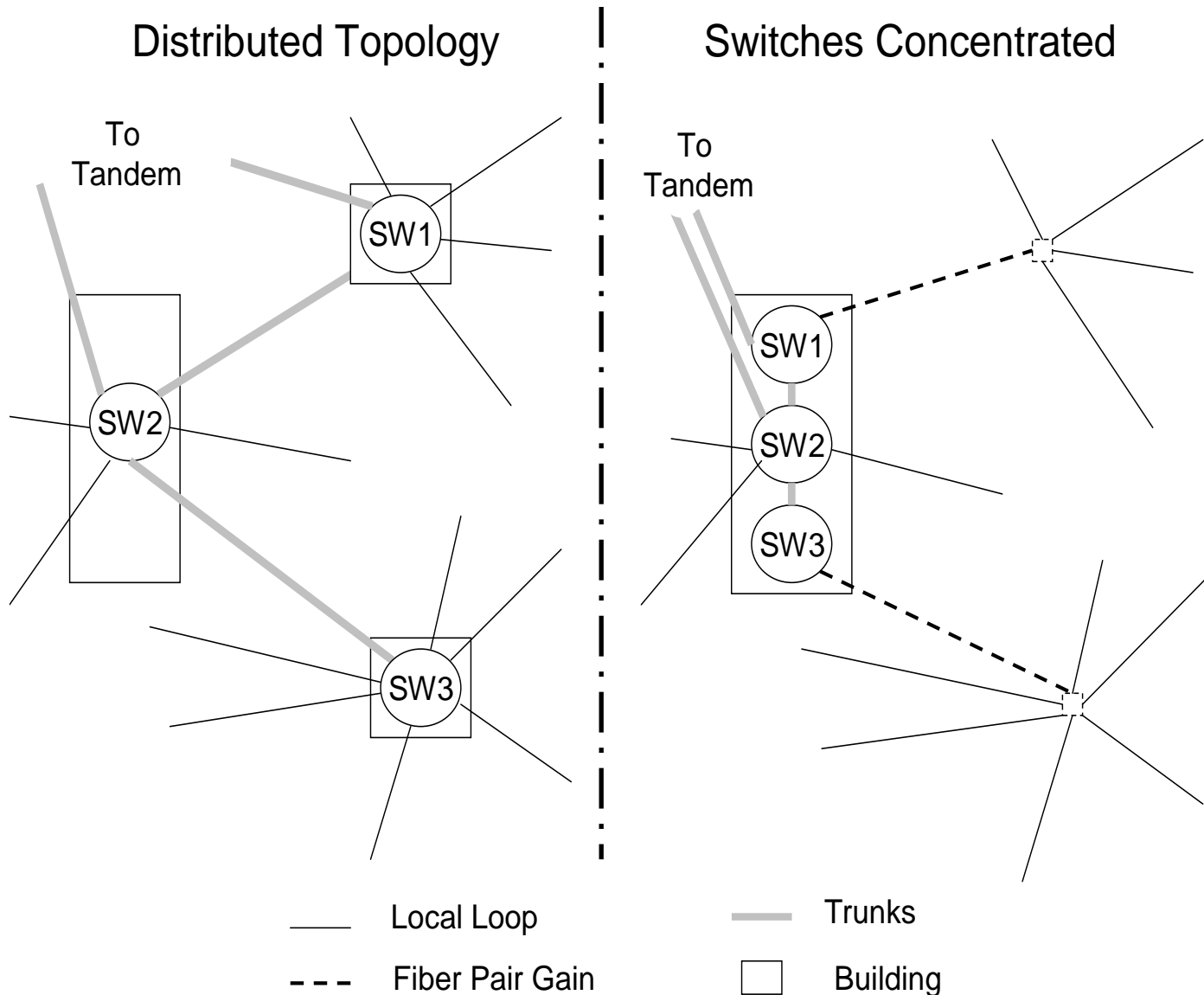

# Proper Public Safety Access Point (PSAP) Deployment

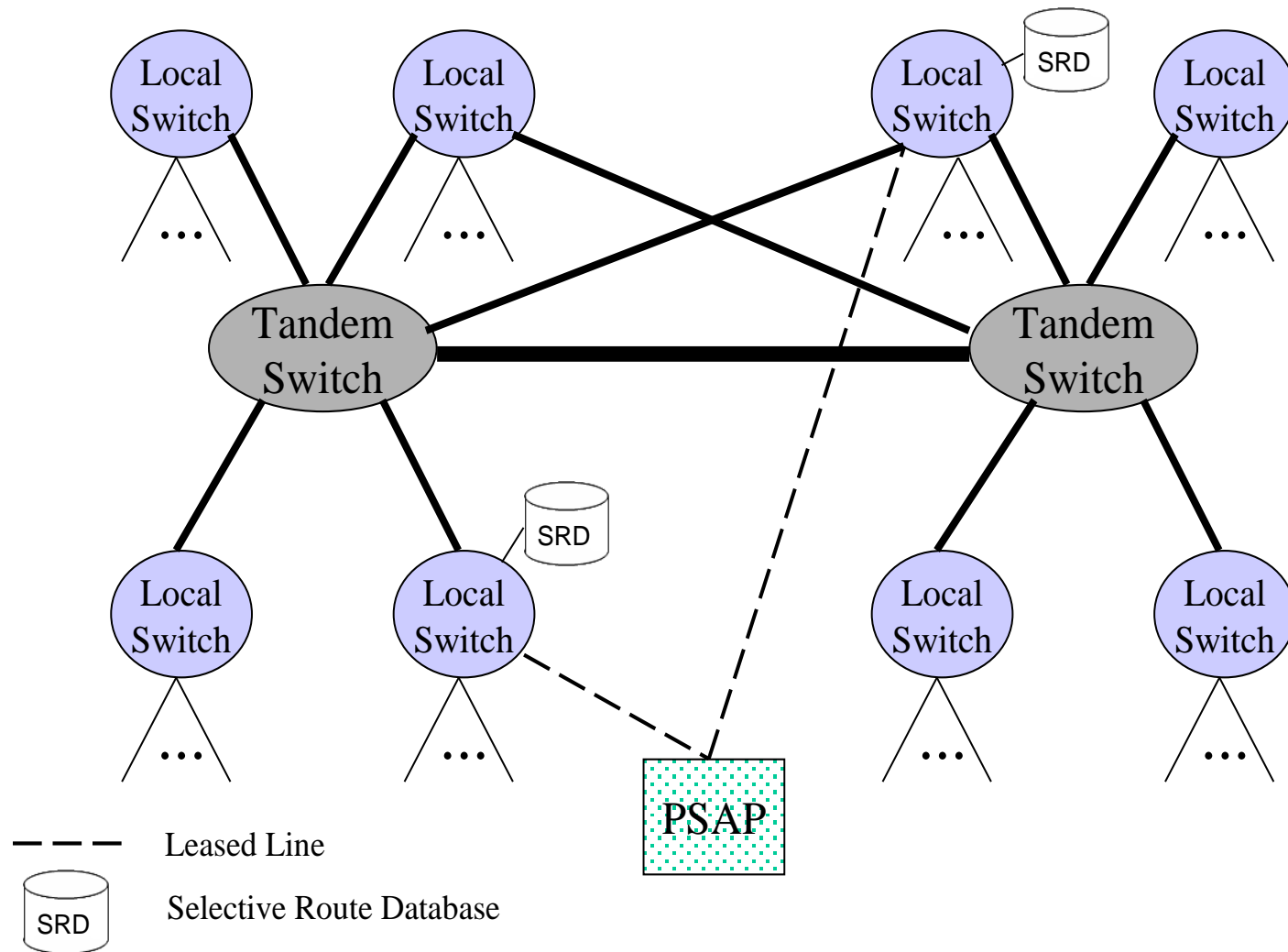



# Wireless Personal Communication Systems

- Architecture
- Mobile Switching Center
- Base Station Controllers
- Base Stations
- Inter-Component Transmission
- Vulnerabilities

# PCS Architecture

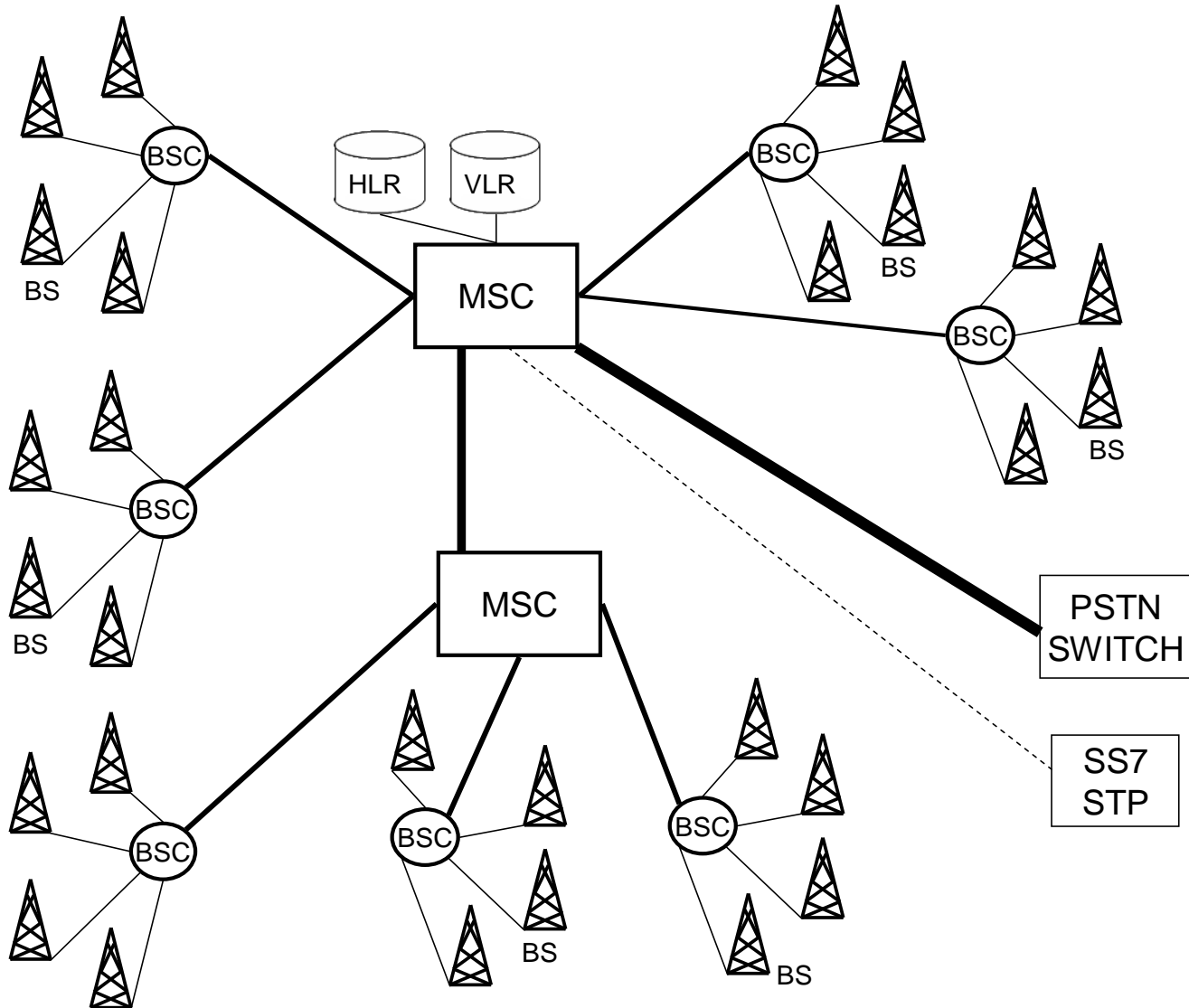

# PCS Component Failure Impact

Components	Users Potentially Affected
Database	100,000
Mobile Switching Center	100,000
Base Station Controller	20,000
Links between MSC and BSC	20,000
Base Station	2,000
Links between BSC and BS	2,000

# Outages at Different Times of Day Impact Different Numbers of People

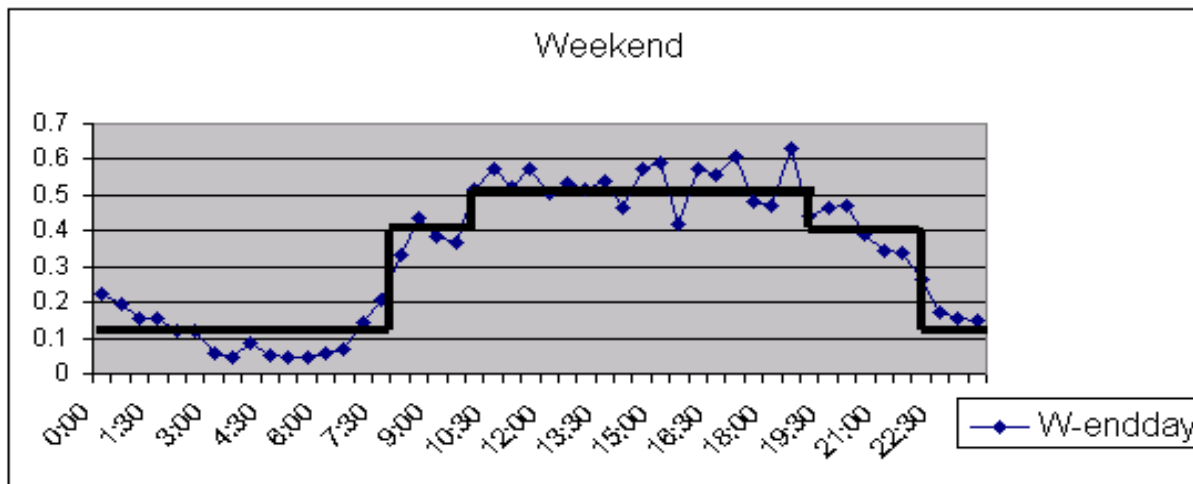
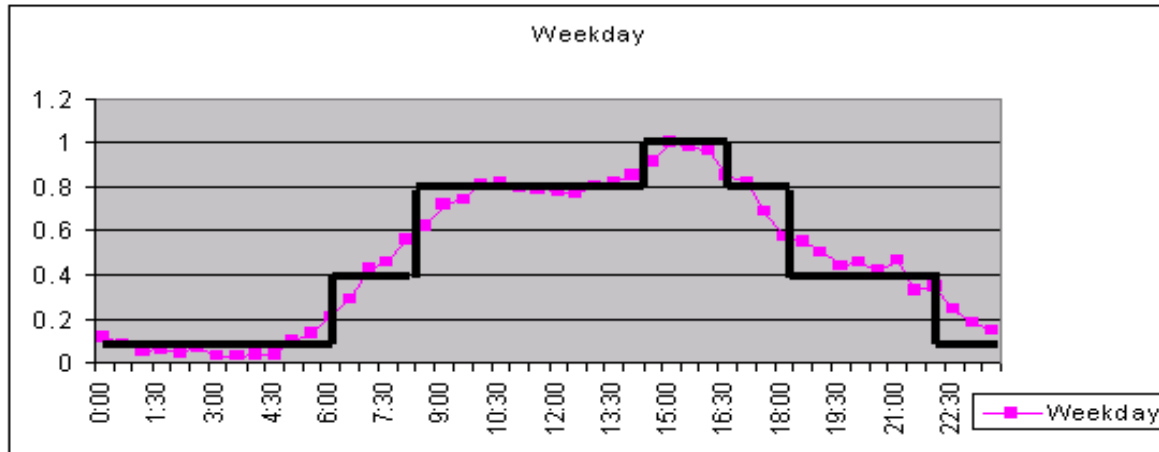

# Concurrent Outages are a Challenge for Network Operators

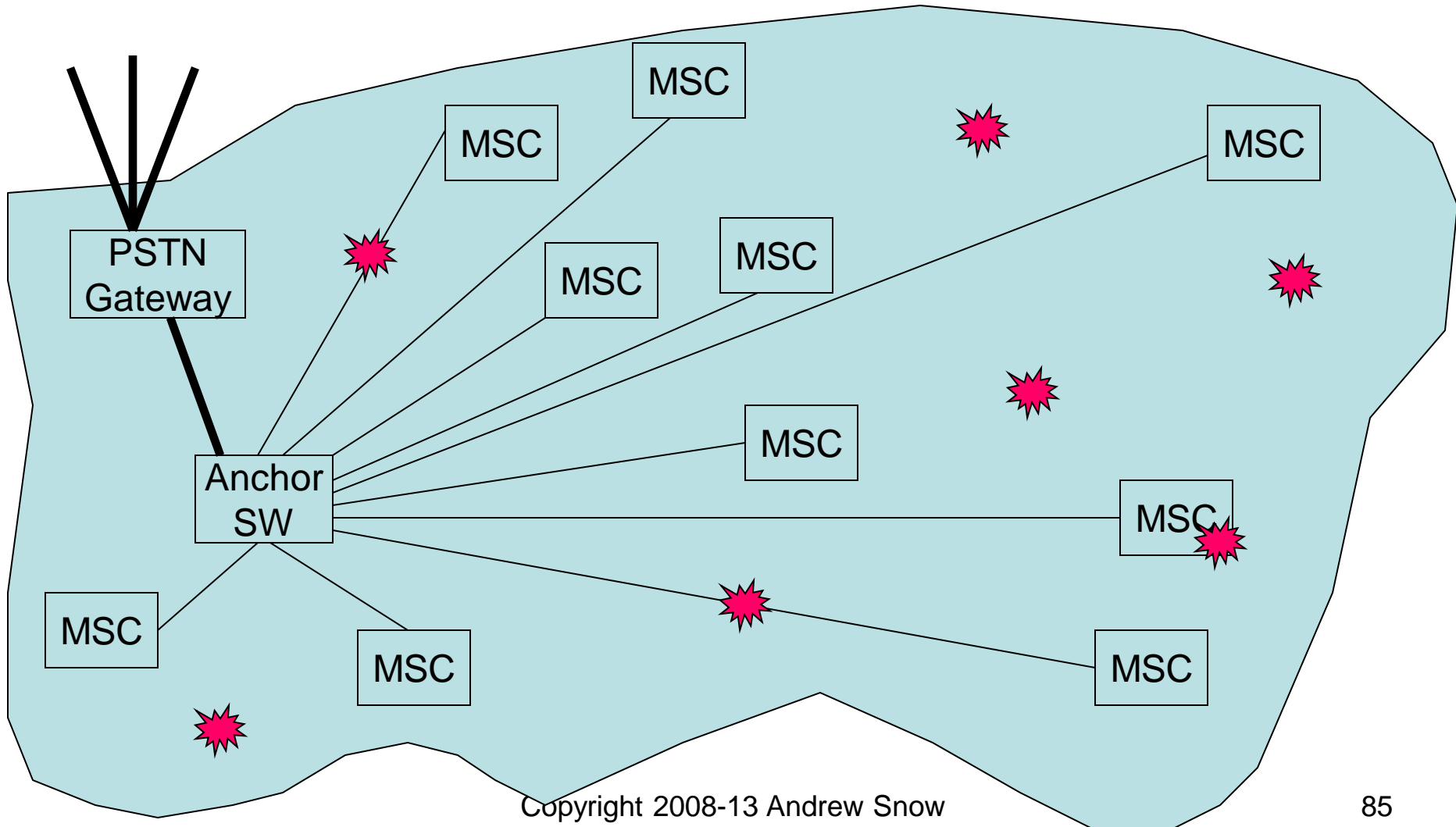

# Episodic Outage Events

- Episodes defined as events when either
  - A Single outage occurs, or
  - Multiple concurrent outages are ongoing

Percentage of customer served

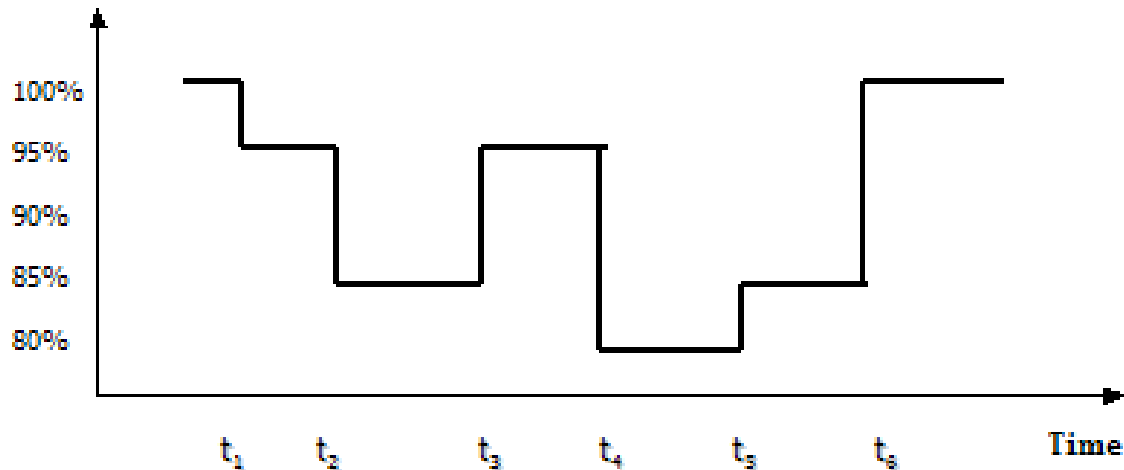

# Distribution of Multi-outage Episodes over One Year

<b>No. Outages in Epoch</b>	<b>Number of WIB</b>				
	<b>2 (200K)</b>	<b>4 (400K)</b>	<b>6 (600K)</b>	<b>8 (800K)</b>	<b>10 (1 M)</b>
1	105	191	254	304	342
2	4	18	38	54	77
3	0	2	7	14	21
4	0	0	1	3	5
5	0	0	0	0	1
6	0	0	0	0	0
7	0	0	0	0	0

Andy Snow, Yachuan Chen, Gary Weckman, "The Impact of Multi-Outage Episodes on Large-Scale Wireless Voice Networks," *The International Journal on Networks and Services*, vol 5, no 3&4, pages: 174 – 188, 2012, IARIA.

# Cable Voice/Data Systems

- Architecture
- Head End
- Transmission (Fiber and Coaxial Cable)
- Cable Internet Access
- Cable Telephony
- Vulnerabilities



# Example of Voice/Data/Video Architecture

## Cisco End-to-End Cable Video Network

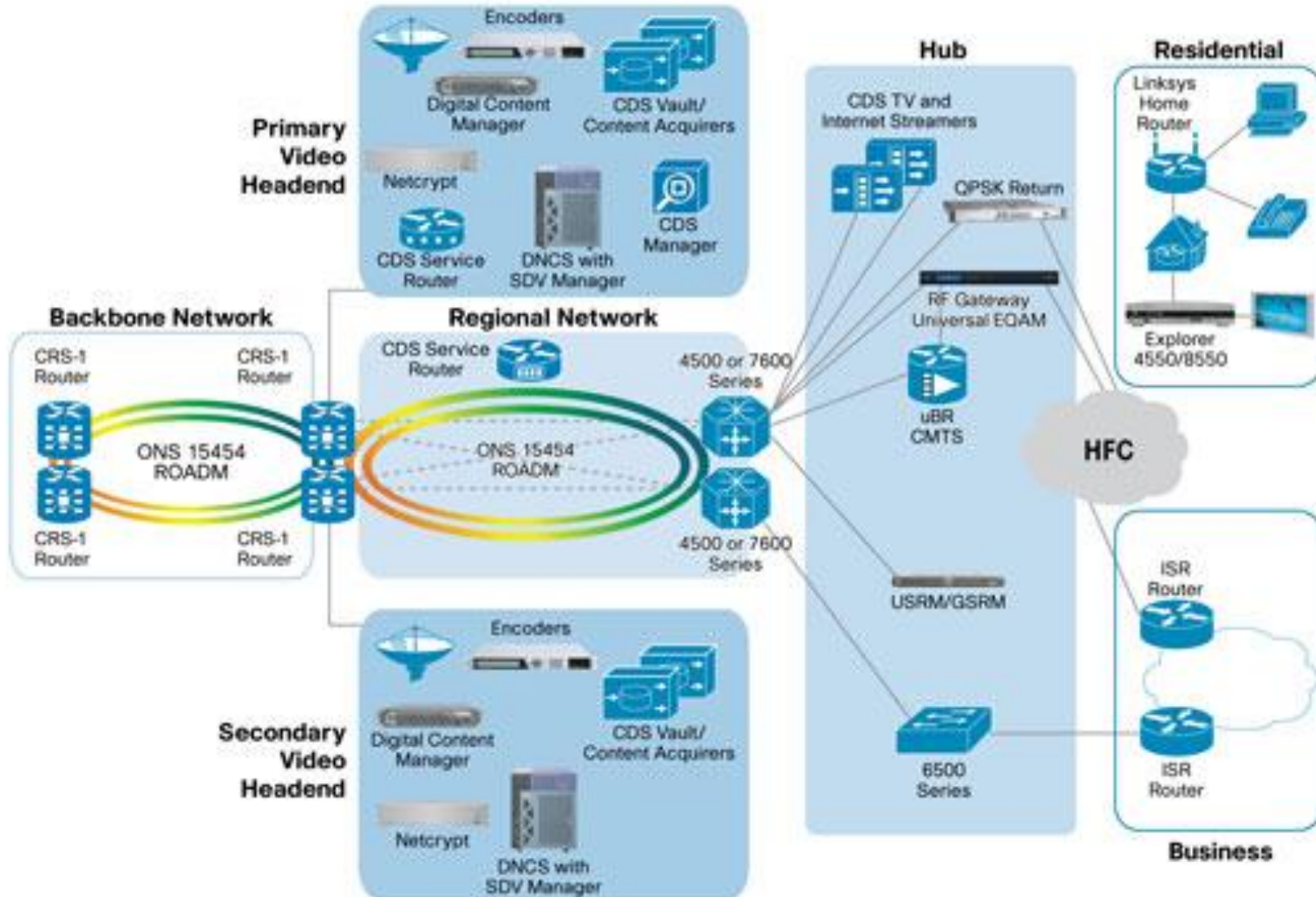

# Infrastructure Interdependencies of the Public Switched Network

- PSTN and Wireless
- PSTN and Voice over IP (VoIP)
- PSTN and Internet
- PSTN and Virtual Private Networks

# Circuit to Packet Switch Interface

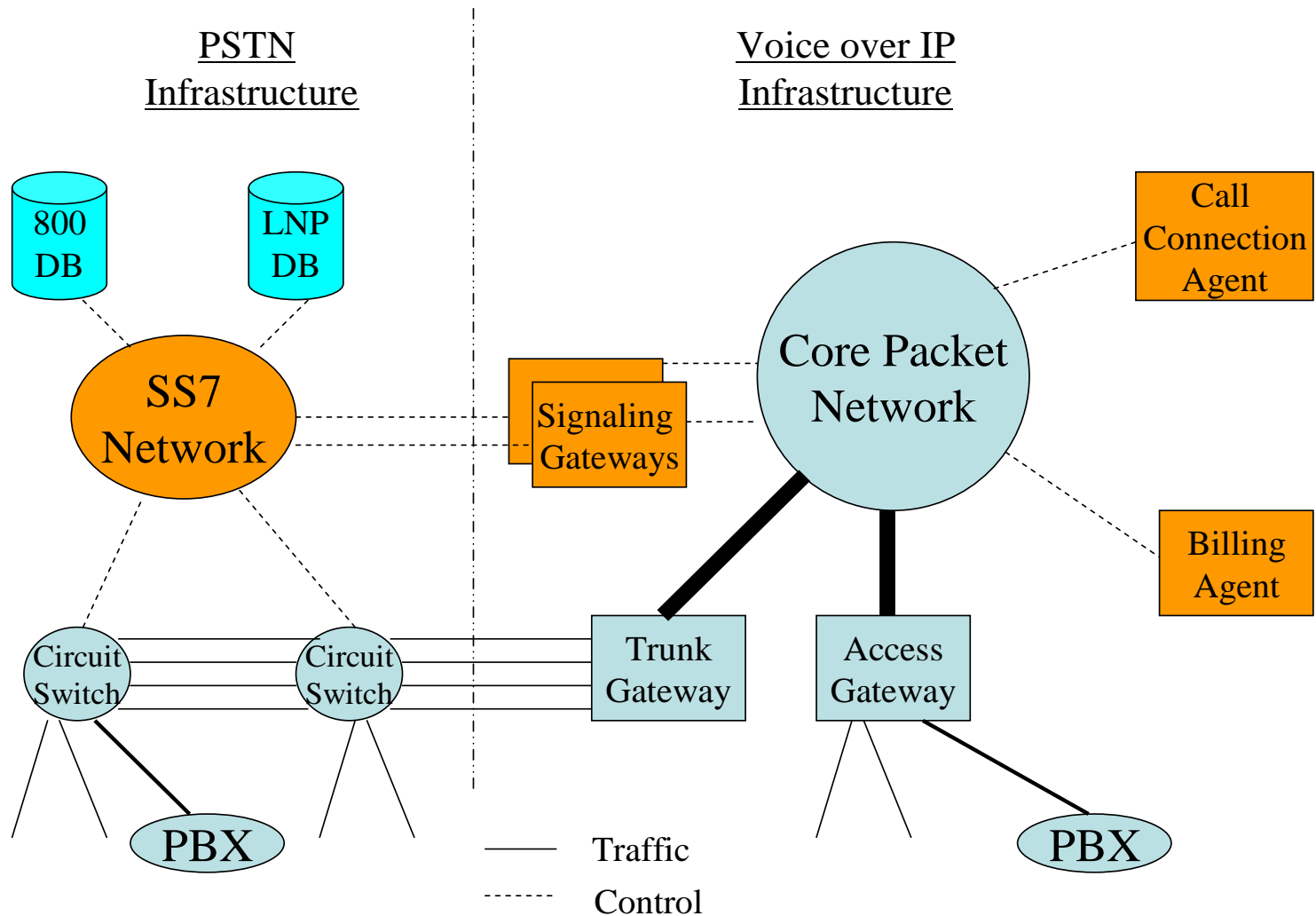

# Cross Utility Sector Interdependencies

- Physical Concurrency of Utility Infrastructure
- Dependence of SCADA on Telecommunication Capabilities
- Dependence of Telecommunication Infrastructure on Power

# Electric Utility Network Architecture

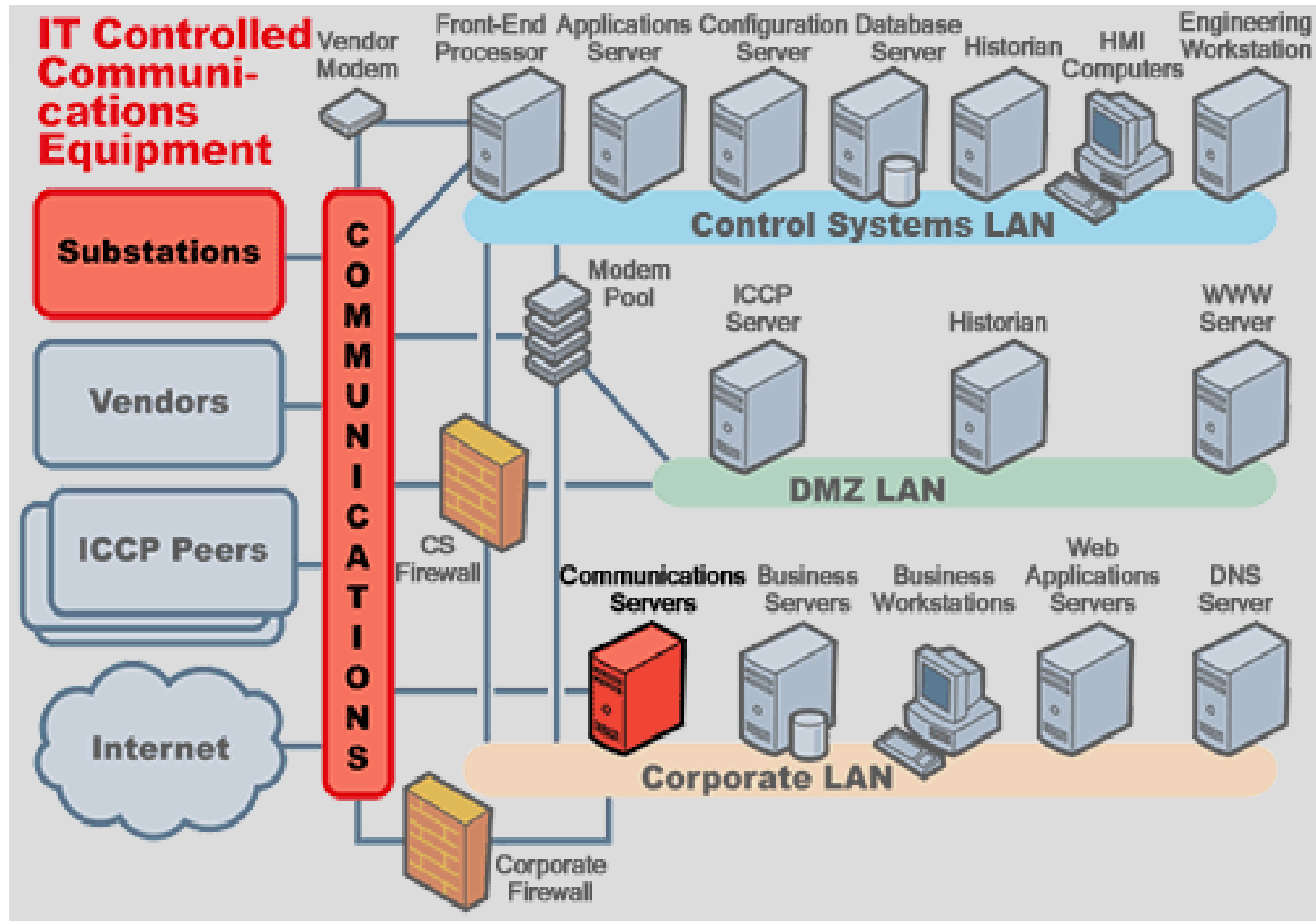

*Source: DHS*

# Vulnerabilities

- Adoption of TCP/IP as a de facto standard for all data communications, including real-time control systems in many industries including energy.
- Bias toward Commercial Off-the-Shelf (COTS) software including both applications and operating systems in order to accelerate development and reduce costs.
- Note that “Open Source” software such as Linux appears not to have a foothold in production systems among utilities.

## Distribution of external SCADA incident types for 2002 to 2006

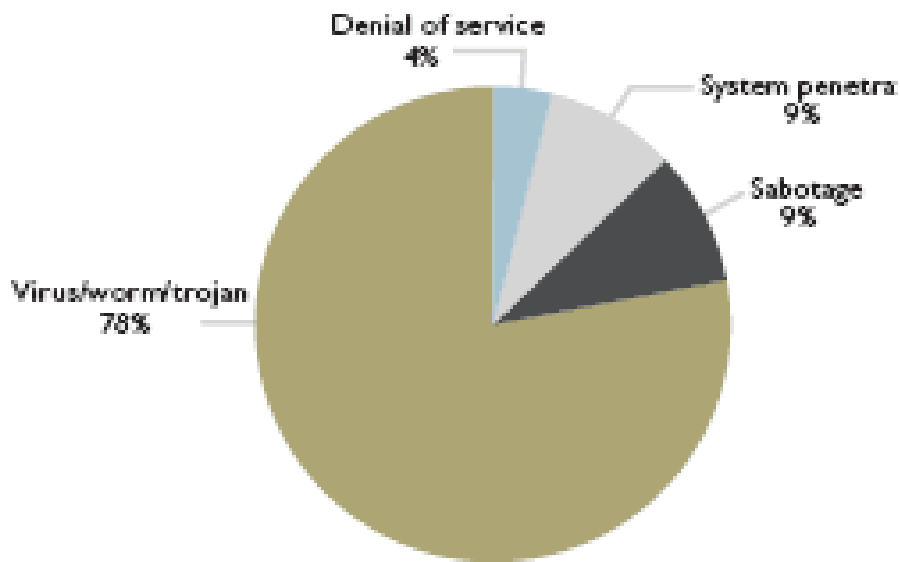

## Remote SCADA points of entry from 2002 to 2006

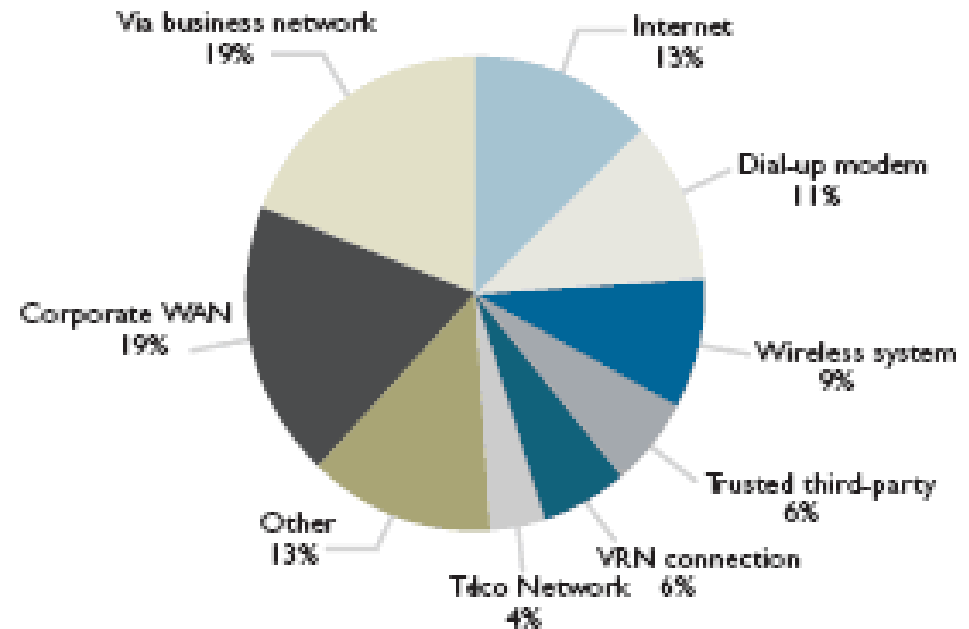

# Outline

- A. Telecom & Network Infrastructure Risk**
- B. Telecommunications Infrastructure**
- C. RAMS: Reliability, Availability, Maintainability and Survivability***
- D. Protection Level Assessment & Forecasting**



# RAMS

- Reliability –  $f( MTTF )$
- Maintainability –  $f( MTTR )$
- Availability –  $f( MTTF, MTTR )$
- Survivability --  $f( MTTF, MTTR, Severity )$
- Survivability Metrics and Thresholds
- User & Carrier Perspectives

# Reliability

- *Reliability* is the chance equipment or a service will operate as intended in its environment for a specified period of time.
- A function of the mean time to failure (MTTF) of the equipment or service.
- Reliability deals with:
  - “How often can we expect this equipment/service to not fail”, or,
  - “What is the expected lifetime of the equipment/service”?

# Mean Time To Failure (MTTF)

- How do we get it?
  - If equipment/service has been fielded, the MTTF is the arithmetic mean of the observed times to fail.
  - If it not yet fielded, it is the predicted lifetime.
- There is a very simple way to calculate the reliability, as shown below:

$$R = e^{-\lambda \cdot t} \qquad \lambda = \frac{1}{MTTF}$$

- $R$  is the reliability, or the chance the service/component will be operational for time  $t$ . Lamda known as the failure rate, or reciprocal of the MTTF.
- This assumes constant reliability, which is often very reasonable. Reliability that changes over time is often modeled as NHHP processes

# Reliability Example

- What is the chance a switch with an MTTF of 5 years will operate without failure for 5 years? 1 year? 1 week?

$$R_{5-Yrs} = e^{-\lambda \cdot t} = e^{-t/MTTF} = e^{-5/5} = e^{-1} = 0.368$$

$$R_{1-Yr} = e^{-\lambda \cdot t} = e^{-t/MTTF} = e^{-1/5} = e^{-0.2} = 0.818$$

$$R_{1-Wk} = e^{-\lambda \cdot t} = e^{-t/MTTF} = e^{-(1/52)/5} = e^{-0.00385} = 0.996$$

# Reliability Curves

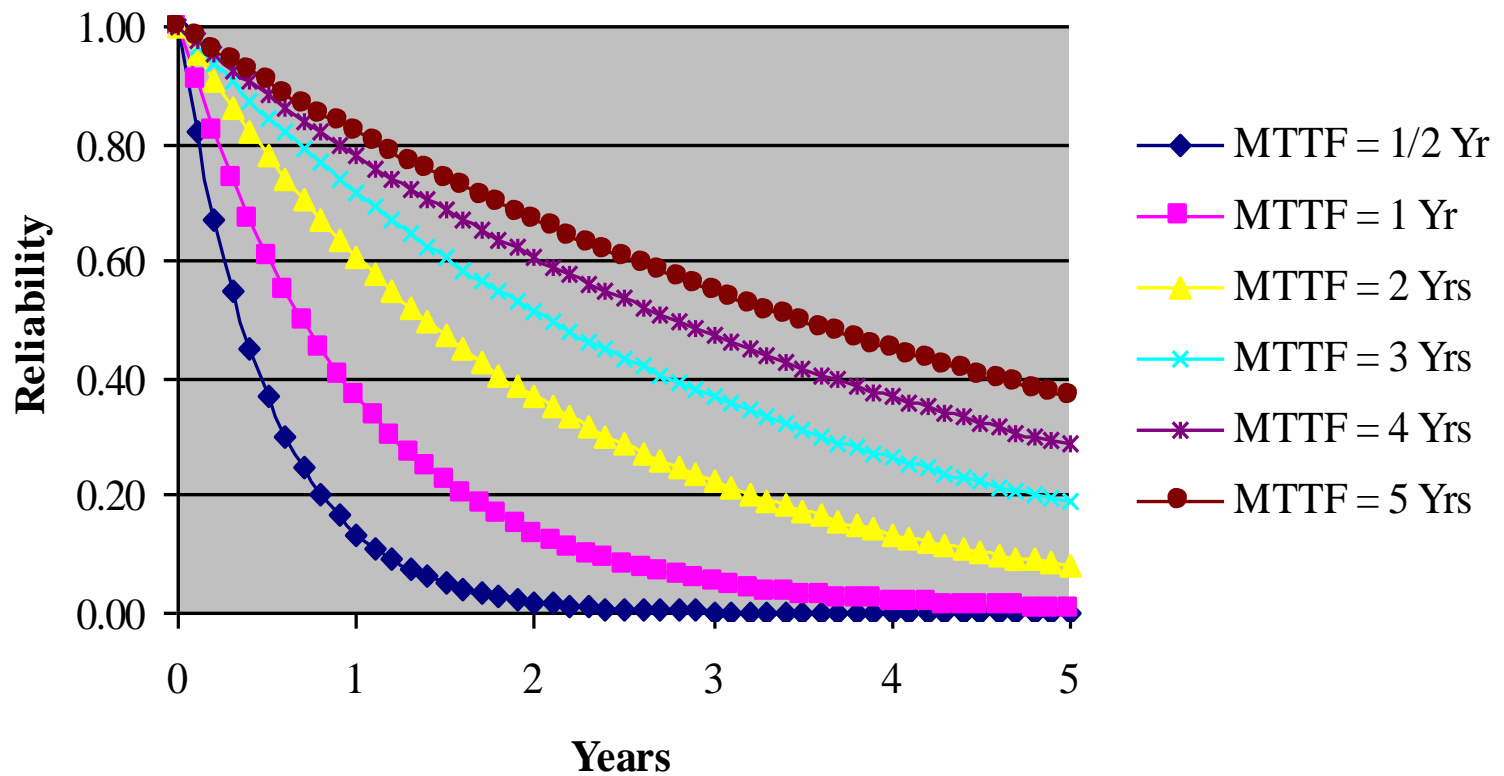

# Maintainability

- *Equipment or Service Maintainability* is the chance a piece of failed equipment will be fixed/replaced in its environment by a specified period of time.
- It is a function of the mean time to repair (MTTR), the inverse of “service rate”, and for exponential repair:

$$M = 1 - e^{-\mu \cdot t} \quad u = \frac{1}{MTTR}$$

- Basically equipment reliability deals with
  - “How fast can we expect to repair/replace this equipment”, or
  - The “expected repair time”.
- The restore time includes the total elapsed time:
  - To realize there is an outage,
  - Isolate the fault,
  - Travel to the fault,
  - Repair the fault,
  - Test the service/component,
  - Put the service/component back into service.

# Maintainability Example

- A DS3 digital circuit has an MTTR of 12 minutes. What is the chance the DS3 will be recovered for use in 1 minute?

$$M_{1-Min} = 1 - e^{-\mu \cdot t} = 1 - e^{-t / MTTR} = 1 - e^{-1/12} = e^{-0.0833} = 0.08$$

# Availability

- Availability is an attribute for either a service or a piece of equipment. Availability has two definitions:
  - The chance the equipment or service is “UP” when needed (Instantaneous Availability), and
  - The fraction of time equipment or service is “UP” over a time interval (Interval or Average Availability).
- Interval availability is the most commonly encountered.
- Unavailability is the fraction of time the service is “Down” over a time interval  $U = 1 - A$



# Availability (Continued)

- Over some time interval, availability can be retrospectively calculated from the total uptime experienced over the interval:
- Availability can also be calculated for a prospective view from the MTTF and MTTR of the equipment or service:
- So availability is a measure of *how often an item/service fails*, and when it does *how long does it take to fix*.
- An availability profile can be shown. The times *between* failure is equal to the time to failure and the time to repair/restore, leading to:

$$A = \frac{UPTIME}{INTERVAL\_TIME}$$

$$A = \frac{MTTF}{MTTF + MTTR}$$

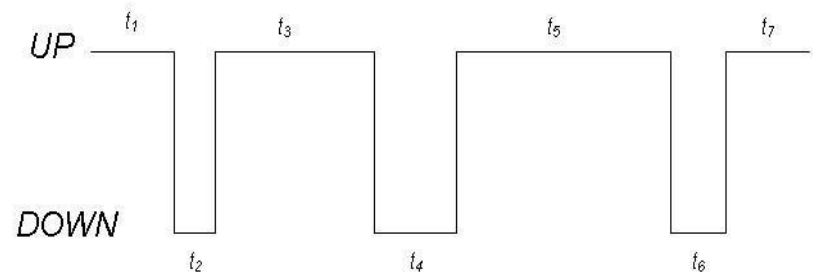

$$MTBF = MTTF + MTTR$$

# Availability Example

- A telecommunications service has an MTTF of 620 hours and an MTTR of 30 minutes.
  - What is the availability of the service?
  - How many hours per quarter can we expect the service to be down?

$$A = \frac{MTTF}{MTTF + MTTR} = \frac{620}{620.5} = 0.99919$$

$$U = 1 - A = 0.00081$$

$$\text{Down\_Time} = 0.00081 \cdot 24\text{hrs} \cdot 30\text{day} \cdot 3\text{months} = 1.74\text{Hours}$$

# Availability Curves

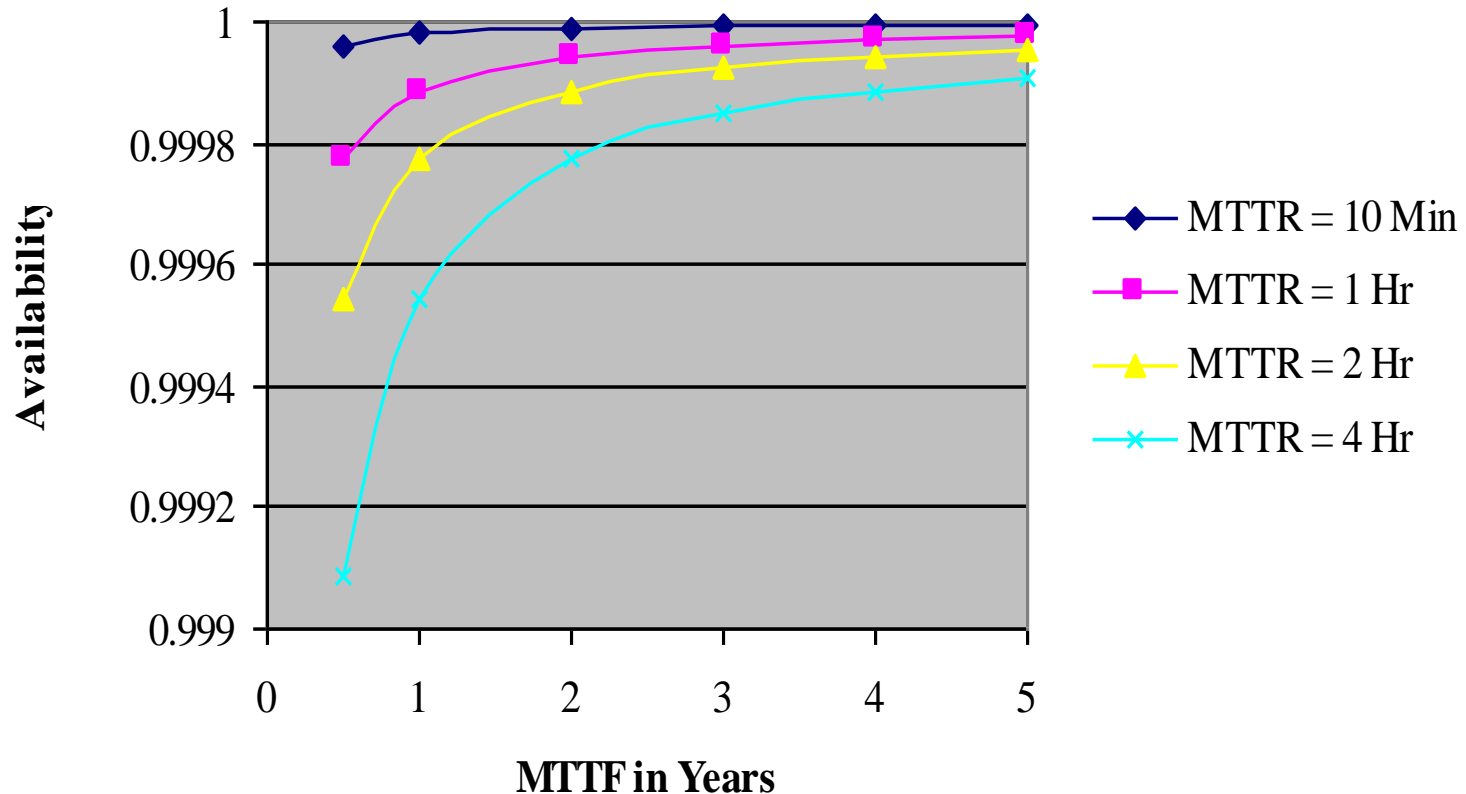

# Survivability

- There are shortcomings with assessing a large telecommunications infrastructure by only RAM perspectives.
- First, the infrastructure often offers many different services over wide geographic areas.
- Second, large telecommunication infrastructures are rarely completely “up” or “down”.
- They are often “partially down” or “mostly up”
- Rare for an infrastructure serving hundreds of thousands or millions of users not to have some small portion of subscribers out at any one time.
- Survivability describes the degree that the network can service users when experiencing service outages

# Outage Profiles

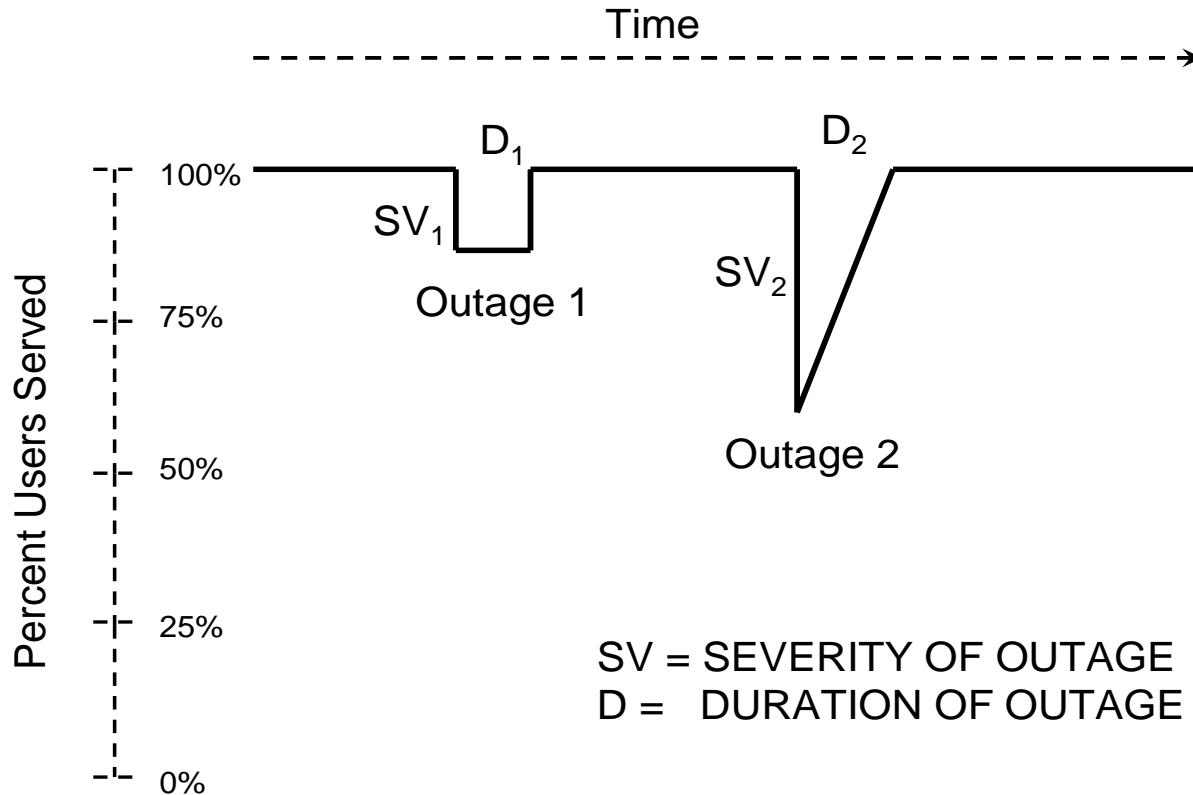

Outage 1: Failure and complete recovery. E.g. Switch failure

Outage 2: Failure and graceful Recovery. E.g. Fiber cut with rerouting

# Survivability Thresholds

- One way to define survivability is to set a severity threshold and observe the fraction of time the infrastructure is in a survival state.
- Why set a threshold? At any instant in a network there are bound to be a small number of users without service.
- Survivability deficits are not small event phenomena.
- We can define survivability as the fraction of time the telecommunications infrastructure is in a survival state,  $MTTNS$  is mean time to non-survival state and  $MTTRTS$  is mean time to restore to a survived state.

$$S = \frac{MTTNS}{MTTNS + MTTRTS}$$

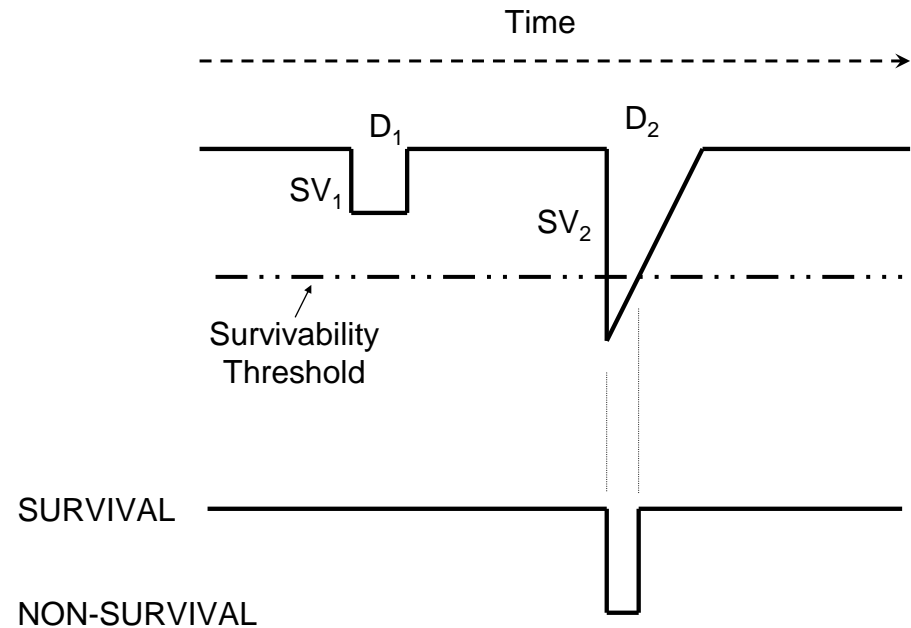

# U.S. Threshold Example – FCC Large-Scale Outage Reporting Requirements

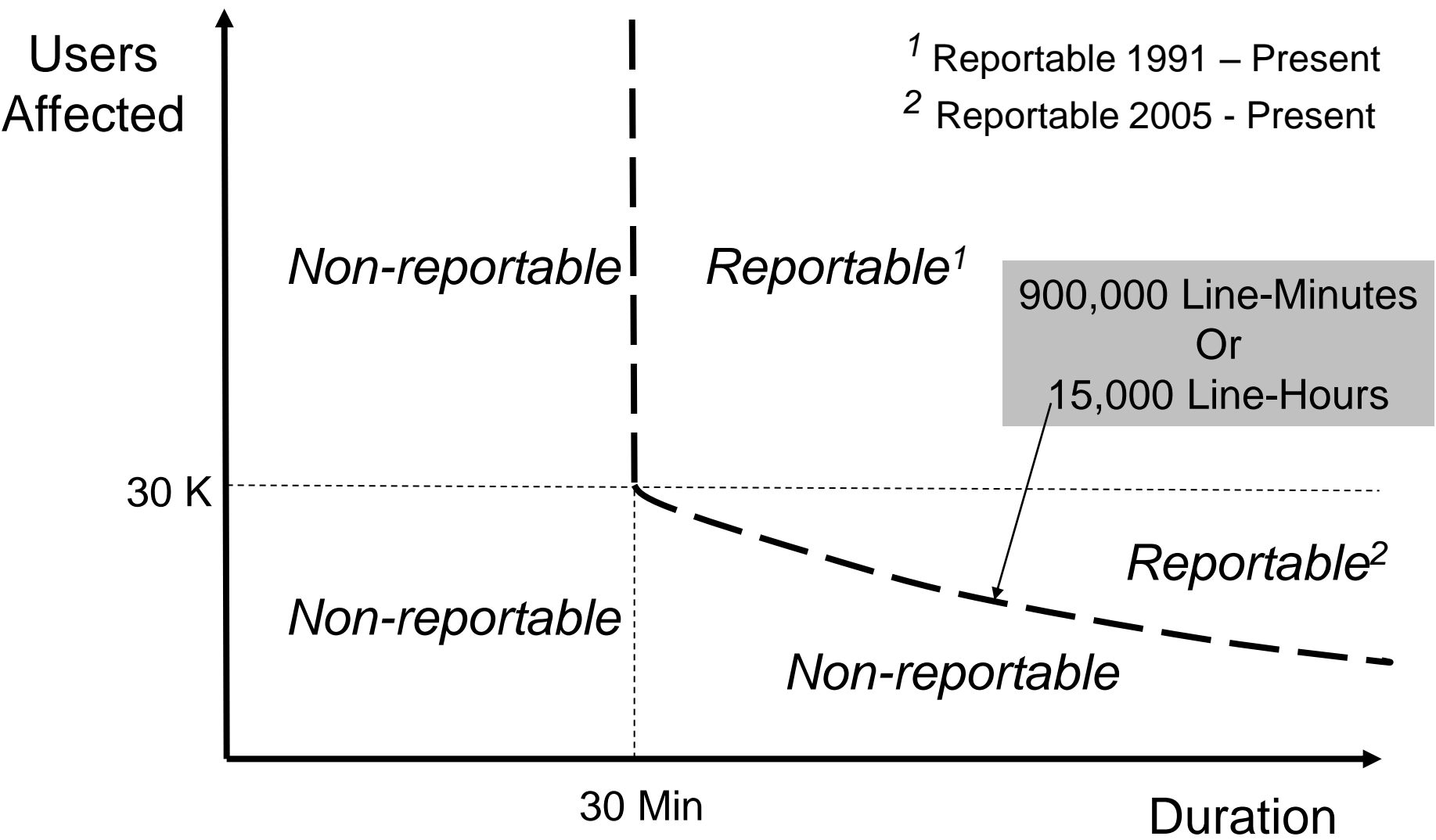

# Severity

- The measure of severity can be expressed a number of ways, some of which are:
  - Percentage or fraction of users potentially or actually affected
  - Number of users potentially or actually affected
  - Percentage or fraction of offered or actual demand served
  - Offered or actual demand served
- The distinction between “potentially” and “actually” affected is important.
- If a 100,000 switch were to fail and be out from 3:30 to 4:00 am, there are 100,000 users *potentially* affected. However, if only 5% of the lines are in use at that time of the morning, 5,000 users are *actually* affected.



# Outages at Different Times of Day Impact Different Numbers of People

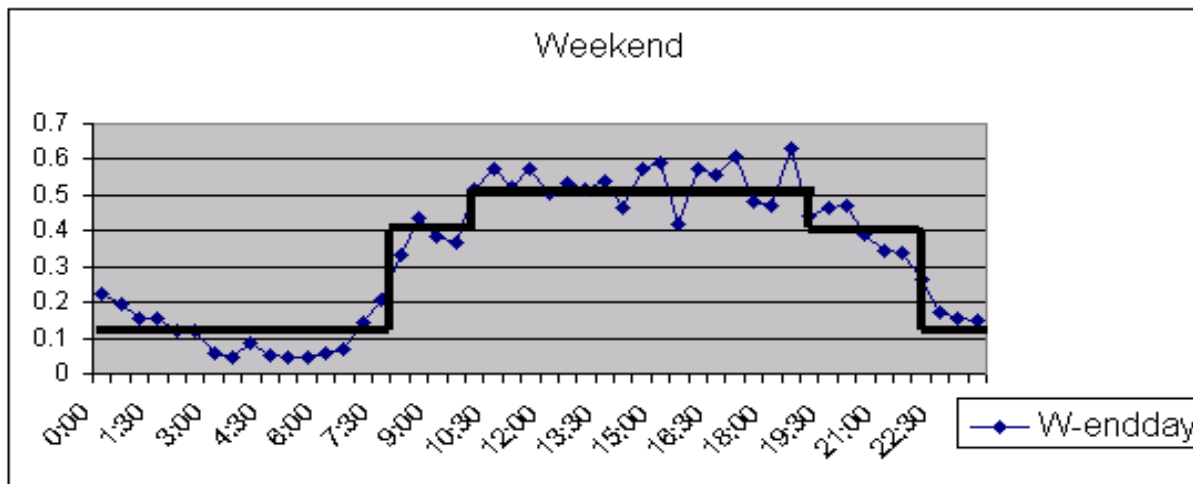
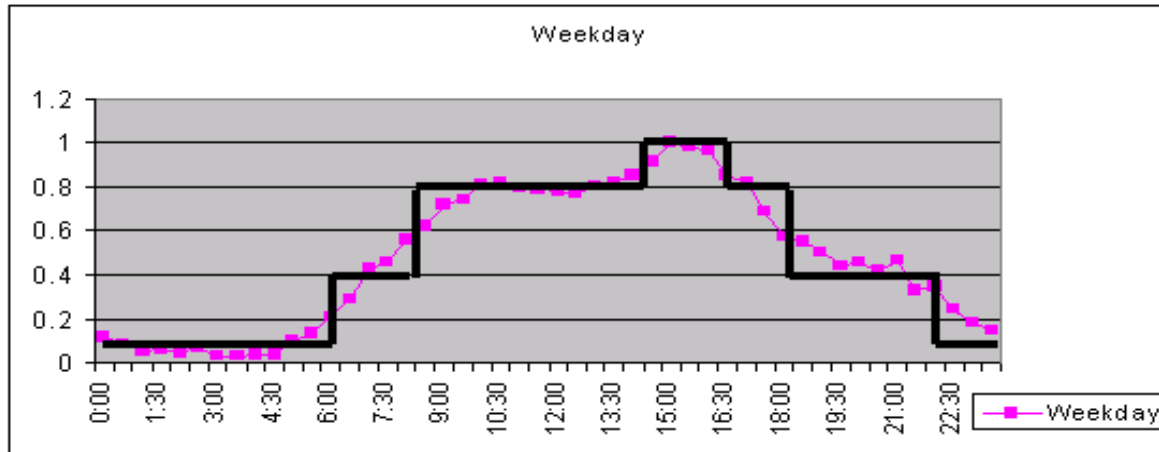

# User & Carrier Perspectives

- User Perspective – High End-to-End Reliability and Availability
  - Focus is individual
- Carrier Perspective – High System Availability and Survivability
  - Focus is on large outages and large customers

# Minimizing Severity of Outages

- It is not always possible to completely avoid failures that lead to outages. Proactive steps can be taken to minimize their size and duration.
  - Avoiding single points of failure that can affect large numbers of users,
  - Having recovery assets optimally deployed to minimize the duration of outages.
- This can be accomplished by:
  - Ensuring there is not too much over-concentration of assets in single buildings or complexes
  - Properly deploying and operating fault tolerant telecommunication architectures
    - Equipment/power fault tolerance
    - Physically and logical diverse transmission systems/paths
  - Ensuring there is adequate trained staff and dispersal of maintenance capabilities and assets

# 9 -11 TCOM Collateral Damage

- The telecommunications facility adjacent to the World Trade Center towers is an example of over-concentration,
  - 4,000,000 data circuits originating, terminating, or passing through that facility, which experienced catastrophic failure with the onset of water/structural damage.
  - Such “Mega-SPFs” ought to be avoided. If they cannot, significant contingency plans/capabilities should exist.

# Outline

- A. Telecom & Network Infrastructure Risk**
- B. Telecommunications Infrastructure**
- C. RAMS: Reliability, Availability, Maintainability and Survivability**
- D. Protection Level Assessment & Forecasting***

# Empirical CIP Assessment

- Industry Best Practices & Standards
- Reviewing Disaster Recovery Plans for Rational Reactive/Proactive Balance
- Outage Data Collection and Analysis

# Industry Best Practices & Standards

- Industry best practices deal with the architecture, design, installation, operations and maintenance activities
- Deviations from best practices should never be accidental, as an inadvertent or unknown deviation represents a latent vulnerability that can be triggered or exploited.
- In the U.S. Wireline best practices were initially developed as a Network Reliability & Interoperability Council (NRIC) initiative. [1]
- The scope of best practices has been expanded to cover the major network types and there are over 700 common best practices.
- A website can be queried by network type, industry role, and keyword:

[1] NRIC is a federal advisory council to the Federal Communications Commission, which has been continuously re-chartered since 1992.

# NRIC Industry Best Practices

- Network Type
  - Cable
  - Internet/Data
  - Satellite
  - Wireless
  - Wireline

- Industry Role
  - Service Provider
  - Network Operator
  - Equipment Supplier
  - Property Manager
  - Government

[www.fcc.gov/nors/outage/bestpractice/BestPractice.cfm](http://www.fcc.gov/nors/outage/bestpractice/BestPractice.cfm)



# Prevention vs. Reaction

- Preventing outages requires both capital and operational expenses.
  - Capital expenditures for such items as backup AC generators, batteries, redundant transmission paths, etc. can be very large.
  - Capital expenses to remove some vulnerabilities might be cost prohibitive, wherein the risk is deemed as *acceptable*.
- Users might not be aware that the service provider has a vulnerability that they do not plan to remediate.
- Regulator and the service provider might have significant disagreements as to what is an acceptable risk.
  - For instance, duct space in metropolitan areas might present significant constraints to offering true path diversity of fiber cables.
  - Or rural local switches might present considerable challenges for designers to offer two separate SS7 access links.

# Prevention vs. Reaction

- Disaster recovery plans are geared toward *reacting* to outages rather than preventing them.
  - It is very important not to overlook the importance of fault removal plans.
- There must be an adequate balance between:
  - Preventing outages and reacting to outages once they have occurred.
  - This is a delicate economic equilibrium point which service providers struggle with.
  - Customers should be aware of this balance and competing perspectives

# Prevention vs. Reaction

- Preventing outages requires both capital and operational expenses.
  - Capital expenditures for such items as backup AC generators, batteries, redundant transmission paths, etc. can be very large.
  - Capital expenses to remove some vulnerabilities might be cost prohibitive, wherein the risk is deemed as *acceptable*.
- Users might not be aware that the service provider has a vulnerability that they do not plan to remediate.
- Regulator and the service provider might have significant disagreements as to what is an acceptable risk.
  - For instance, duct space in metropolitan areas might present significant constraints to offering true path diversity of fiber cables.
  - Or rural local switches might present considerable challenges for designers to offer two separate SS7 access links.
- Disaster recovery plans are geared toward *reacting* to outages rather than preventing them.
  - It is very important not to overlook the importance of fault removal plans.
- There must be an adequate balance between preventing outages and reacting to outages once they have occurred. This is a delicate economic equilibrium point which service providers struggle with.

# Outage Data Collection and Analysis

- Outage data is the bellwether of infrastructure vulnerability.
- The faults which manifest themselves because of vulnerabilities are an indicator of the reliability and survivability of critical telecommunications infrastructure.
- Important to track reliability and survivability in order to assess whether the protection level is increasing, constant, or decreasing.
- Root Cause Analysis (RCA) is instrumental in improvements
  - Trigger
  - Direct
  - Root

# Assessment Case Studies

- Case 1: Wireless Survivability Infrastructure Improvement Assessment with ANN
- Case 2: Chances of Violating SLA by Monte Carlo Simulation
- Case 3: TCOM Power Outage Assessment by Poisson Regression & RCA
- Case 4: SS7 Outages Assessment by Poisson Regression & RCA

# Case 1: Wireless Survivability Infrastructure Improvement Assessment with ANN

“Evaluating Network Survivability Using Artificial Neural Networks” by Gary R. Weckman, Andrew P. Snow and Preeti Rastogi

“Assessing Dependability Of Wireless Networks Using Neural Networks” by A. Snow, P. Rastogi, and G. Weckman

# Introduction

- Critical infrastructures such as network systems must exhibit resiliency in the face of major network disturbances
- This research uses computer simulation and artificial intelligence to introduce a new approach in assessing network survivability
  - A discrete time event simulation is used to model survivability
  - The simulation results are in turn used to train an artificial neural network (NN)
- Survivability is defined over a timeframe of interest in two ways:
  - As the fraction of network user demand capable of being satisfied and
  - As the number of outages experienced by the wireless network exceeding a particular threshold

# Wireless Infrastructure Block (WIB)

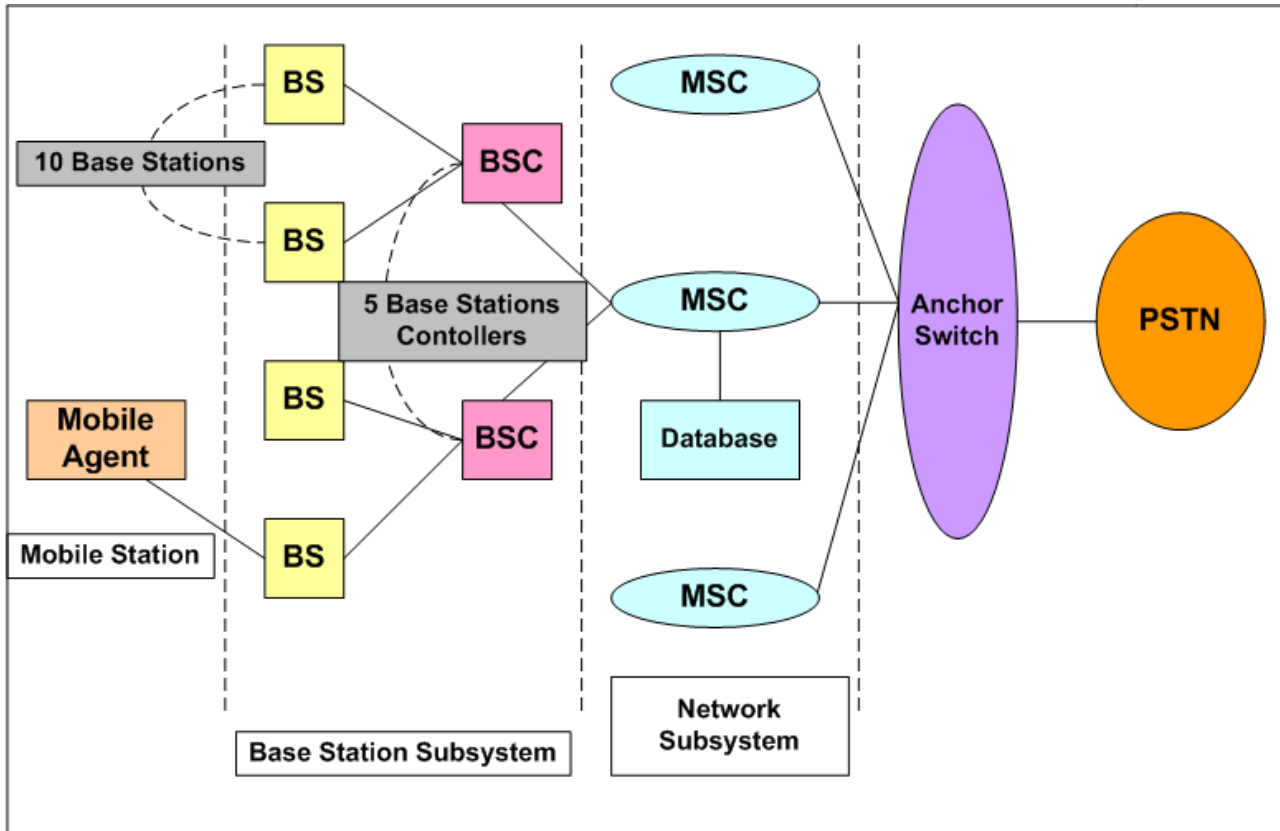

- MSC: Mobile Switching Center
- PSTN: Public Switching Telecommunication Network Signaling
- SS7: System Numbering 7



# WIB Characteristics

Components	Quantity in Each WIB
Database	1
Mobile Switching Center	1
Base Station Controller	5
Links between MSC and BSC	5
Base Station	50
Links between BSC and BS	50

Components	Customers Affected
Database	100,000
Mobile Switching Center	100,000
Base Station Controller	20,000
Links between MSC and BSC	20,000
Base Station	2,000
Links between BSC and BS	2,000

# Reliability and Maintainability Growth, Constancy, and Deterioration Scenarios

		Maintainability Growth, Constancy, Deterioration		
		MG	MC	MD
Reliability Growth, Constancy, Deterioration	RG			
	RC			
	RD			

# Simulation and Neural Network Model

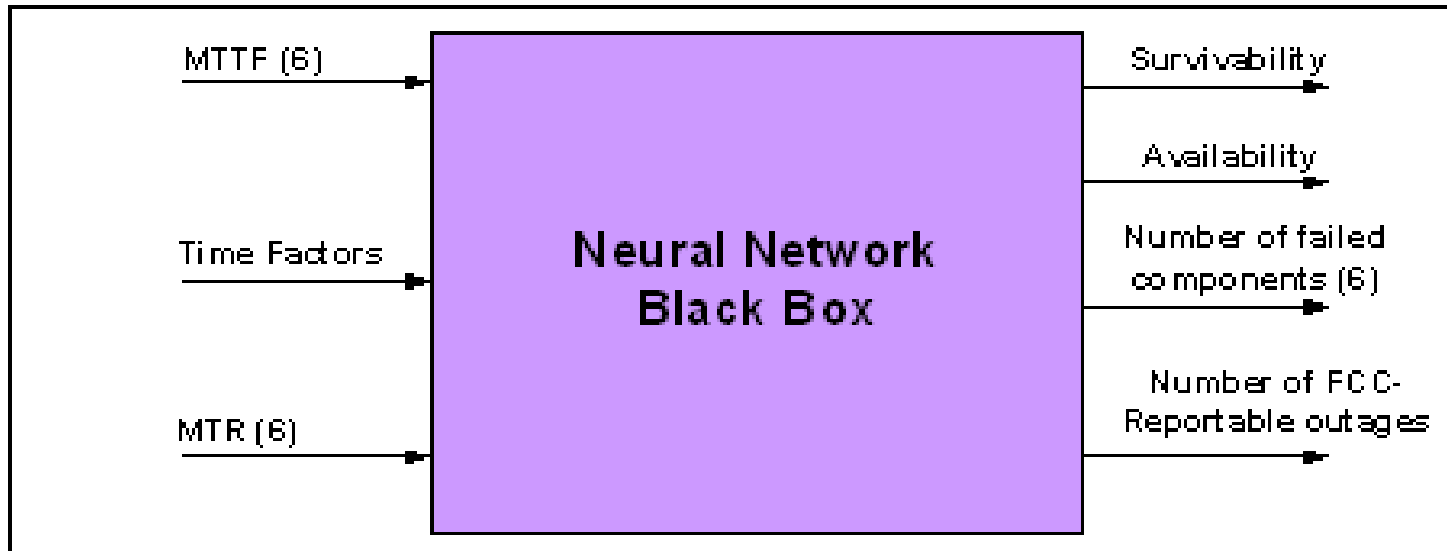
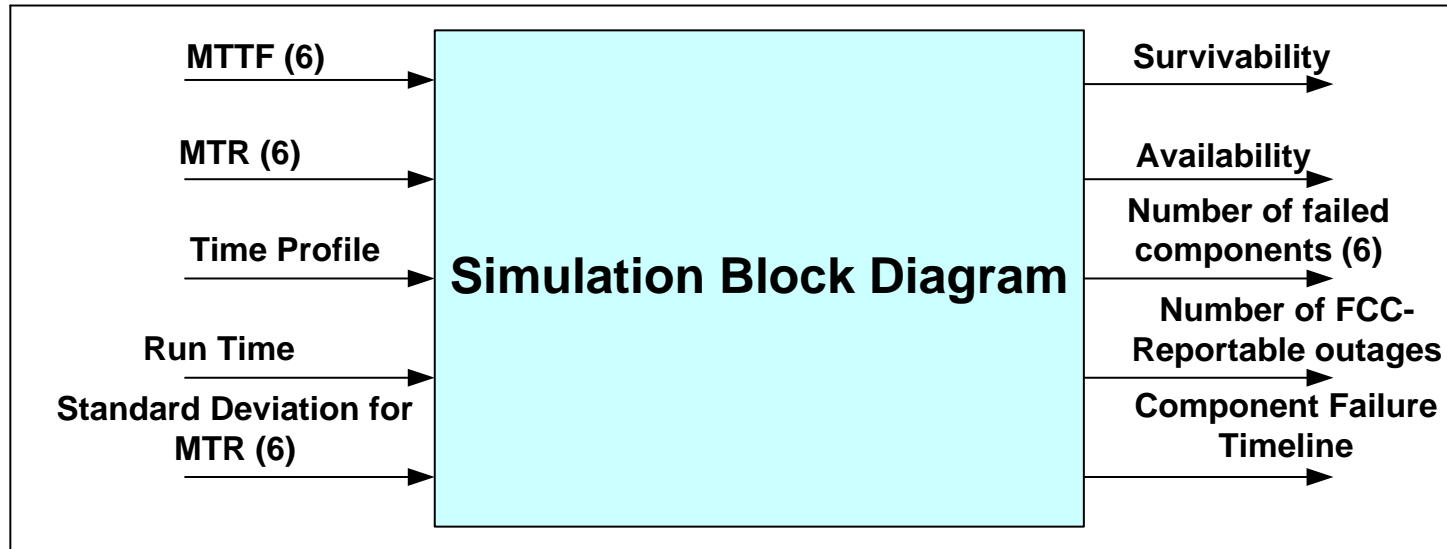

# Biological Analogy

- Brain Neuron

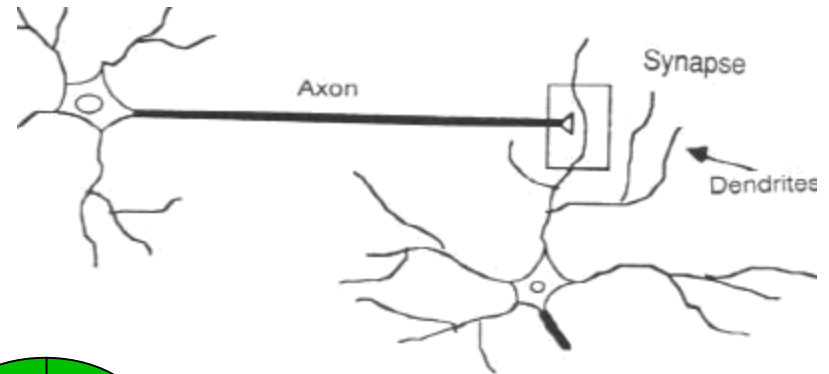

- Artificial neuron

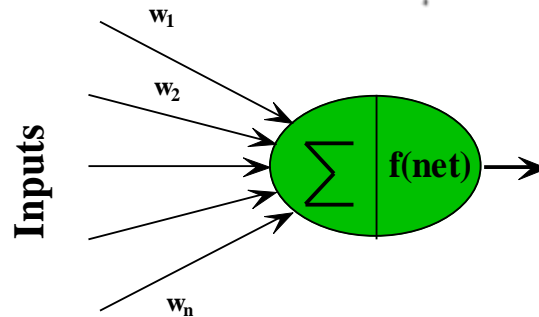

- Set of processing elements (PEs) and connections (weights) with adjustable strengths

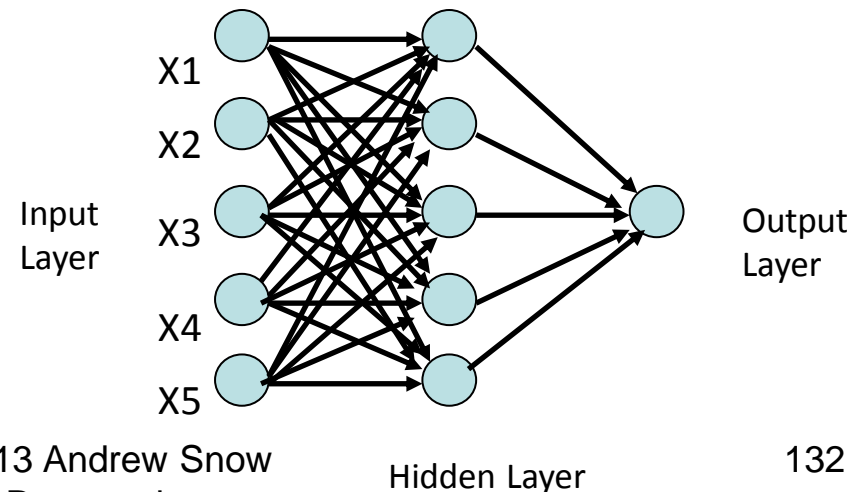

# ANN Model

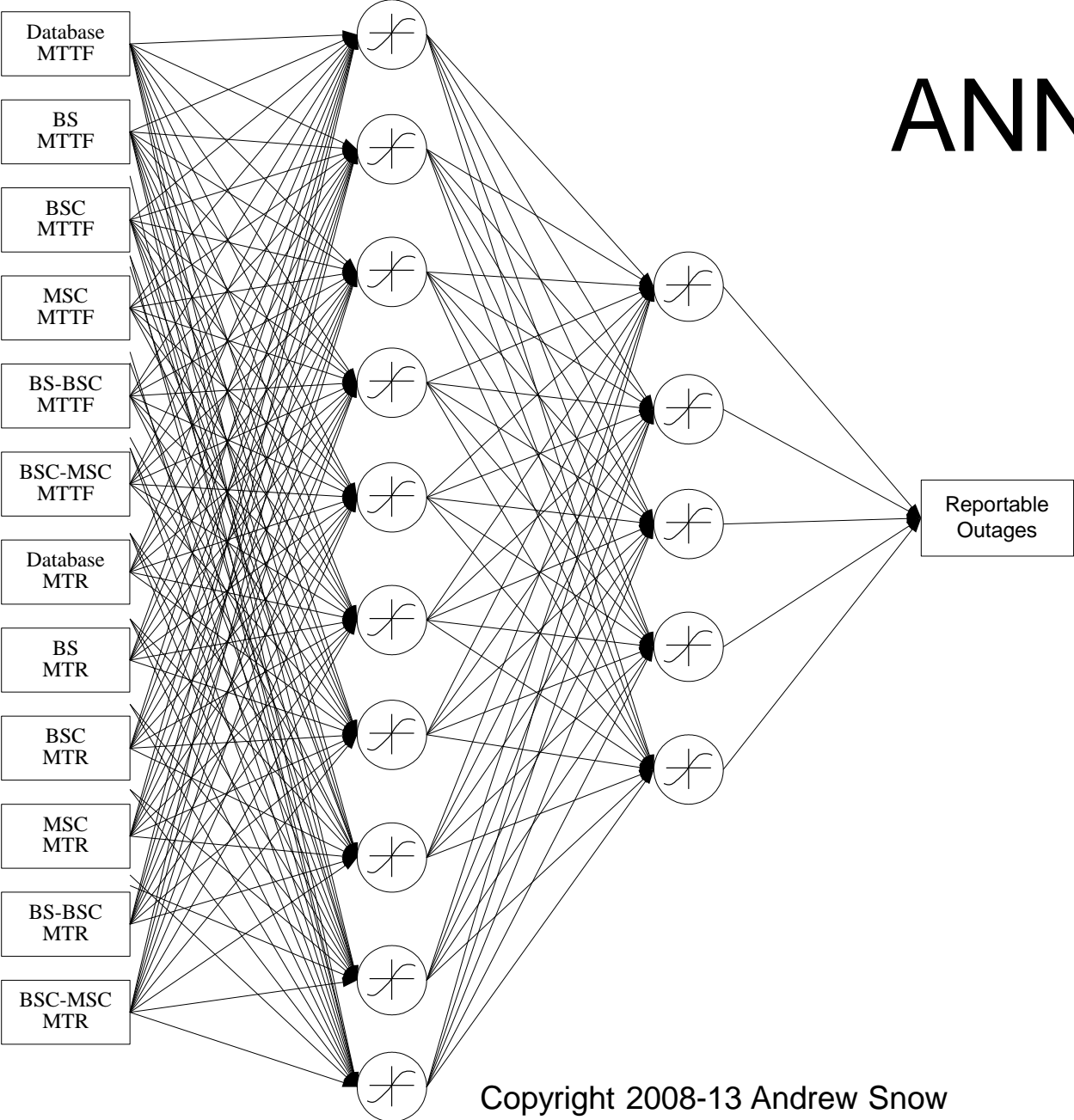

# Research Methodology

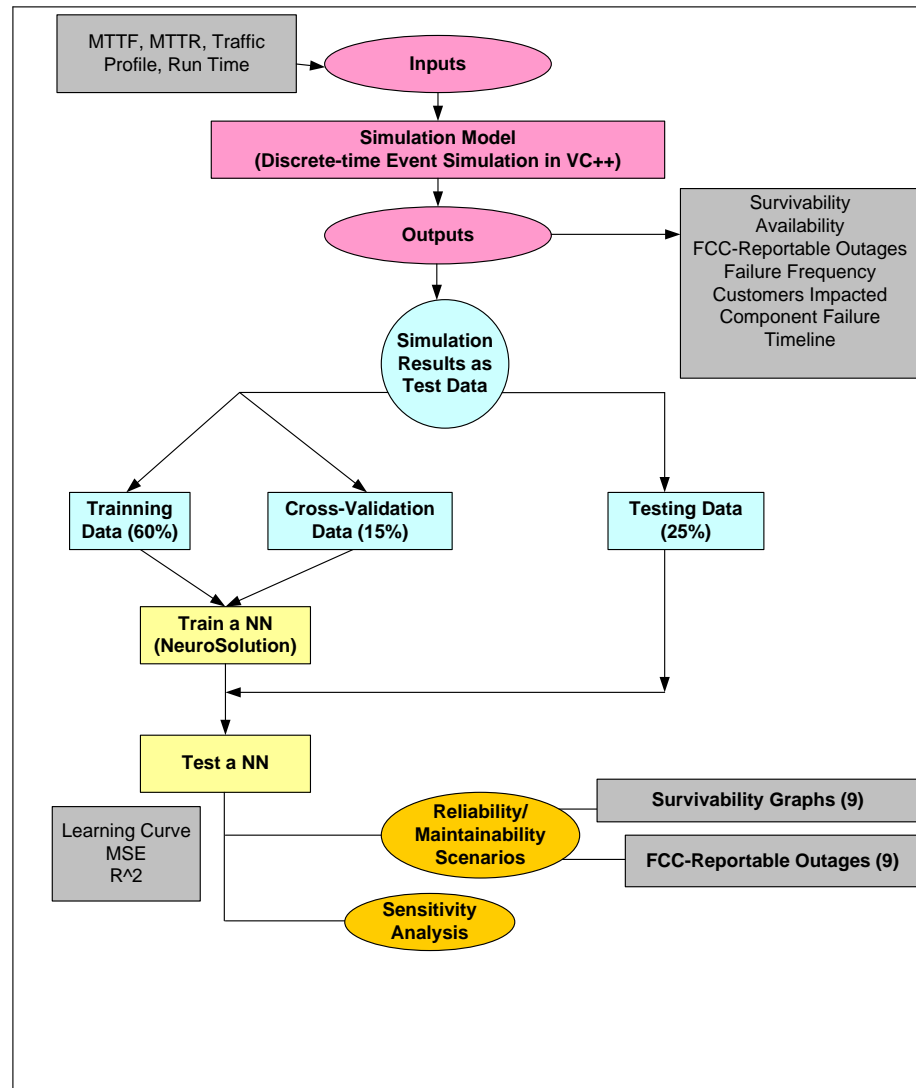

# Simulation Vs Neural Network Outputs for FCC-Reportable Outages

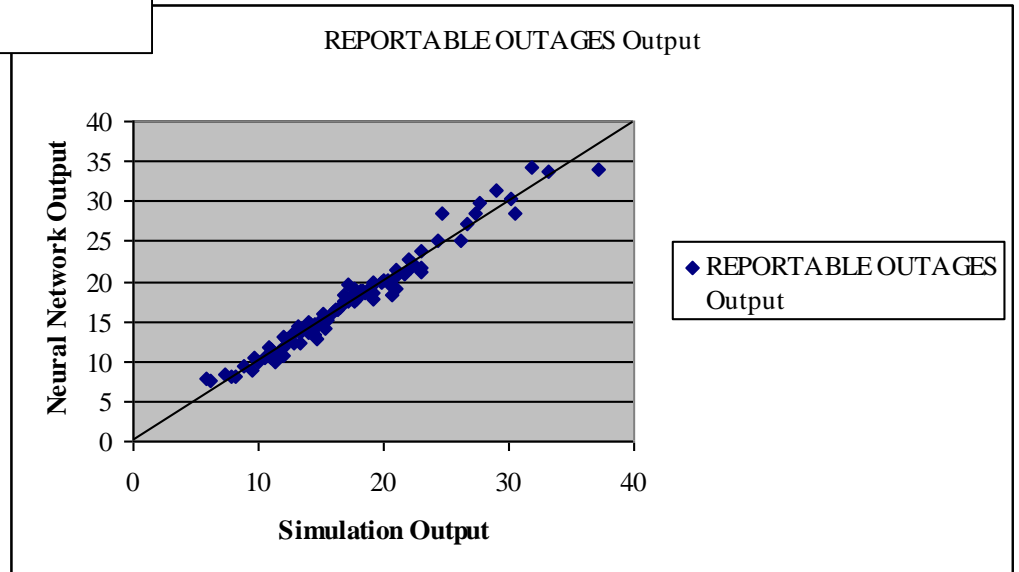
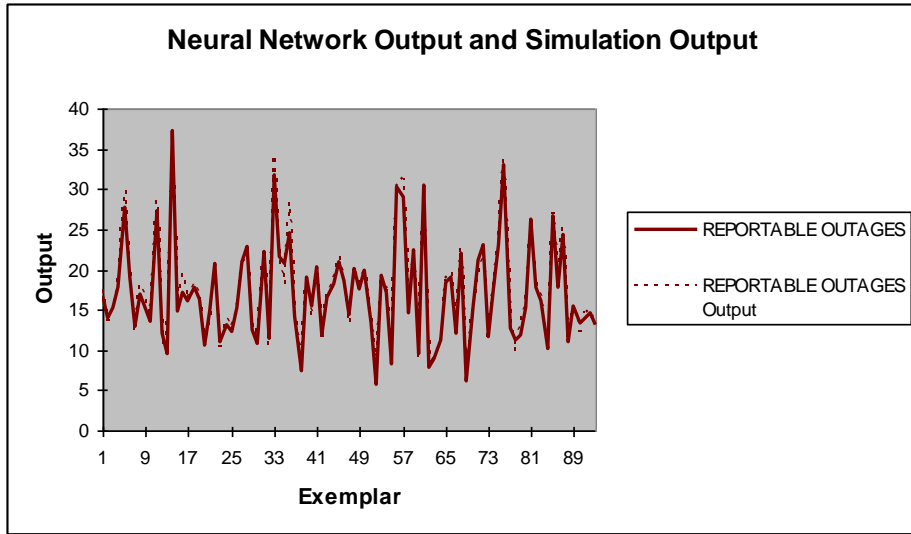

# Sensitivity Analysis

## FCC-Reportable Outages

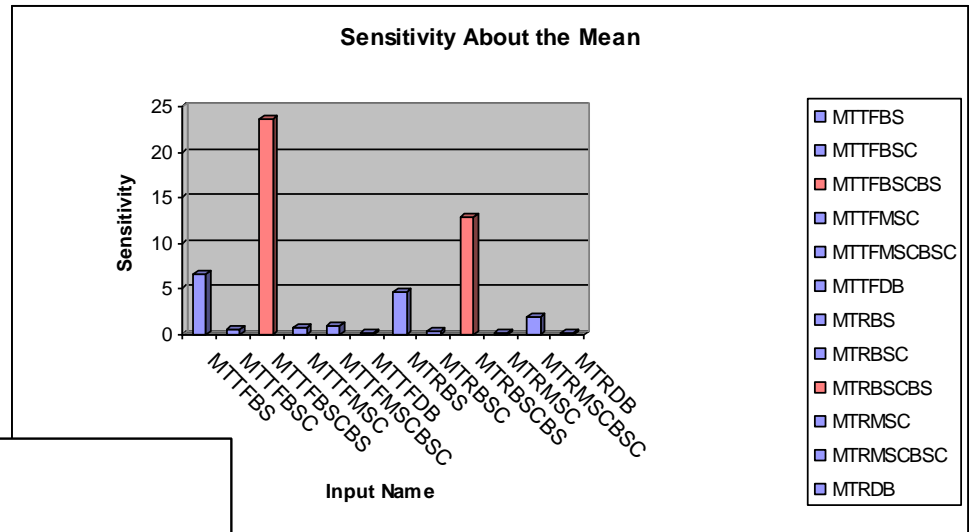

## Survivability

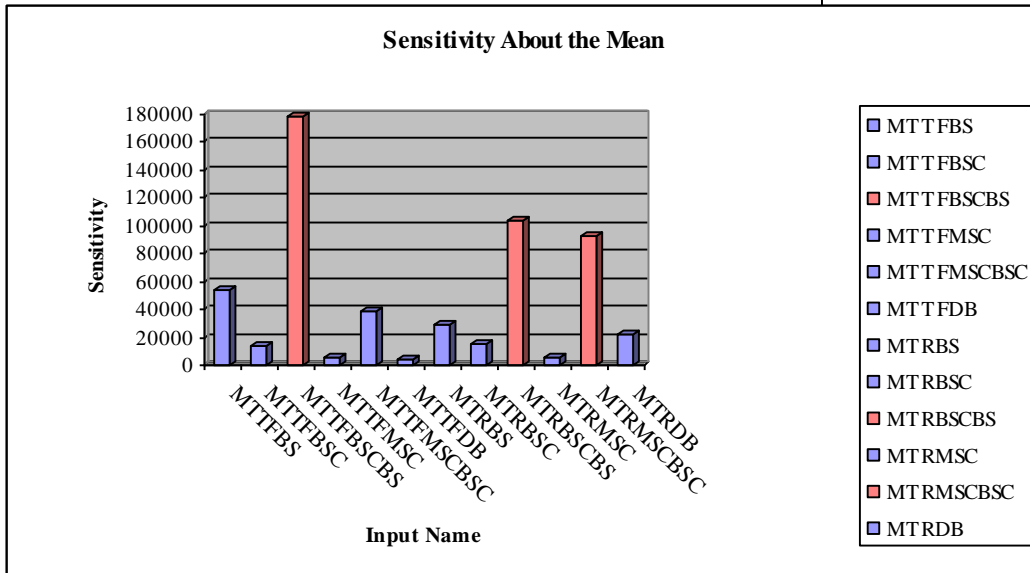



# COMPOUNDED IMPACT ON GROWTH AND DETERIORATION

Years	Compounded Growth (%)	Compounded Deterioration (%)
1	10	10
2	21	19
3	33.1	27.1
4	46.4	34.4
5	61.1	40.9

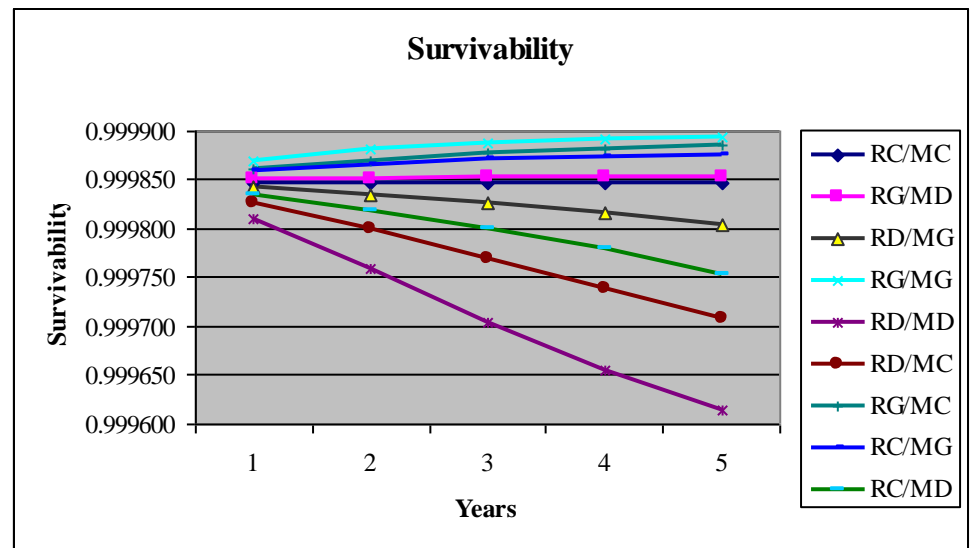
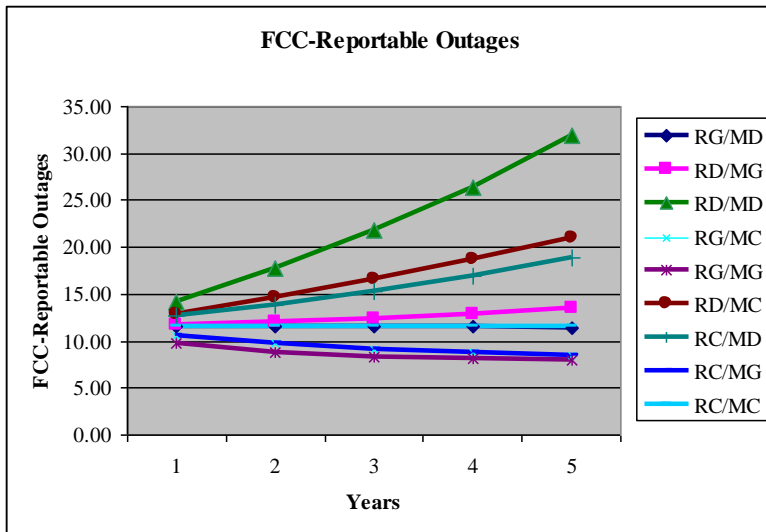

# Conclusions (Continued)

- Reliability and/or maintainability:
  - Deterioration below nominal values affects wireless network dependability more than growth
  - Growth beyond nominal values does not improve survivability performance much
  - Cost/performance ratio plays an important role in deciding R/M improvement strategies.
- Scenario RG/MG gives the lowest value for FCC-Reportable outages, lost line hours and WIB downtime (high survivability)
  - Cost is high for marginal survivability improvement
- Scenario RD/MD indicates massive decreases in survivability
  - Fighting deterioration is more important than achieving growth.

# Conclusions

- For FCC-Reportable outages and survivability, reliability deterioration below the nominal values cannot be compensated by maintainability growth, whereas maintainability deterioration can be compensated by reliability growth.
- Benefits of an ANN model
  - a wireless carrier can find out the expected number of threshold exceedances for a given set of component MTTF and MTTR values
  - Sensitivity analysis tells us the most important components

# Conclusions

- Results indicate neural networks can be used to examine a wide range of reliability, maintainability, and traffic scenarios to investigate wireless network survivability, availability, and number of FCC-Reportable outages
- Not only is NN a more efficient modeling method to study these issues, but additional insights can be readily observed
- Limitations of study:
  - Only one wireless infrastructure building block (WIB) and does not include the entire wireless network integrated with PSTN
  - Modeling for 2G+ generation, however topology/hierarchy has similarities with 3G and 4G
  - Optimization is completed without the involvement of a cost function and hence economic considerations are not entertained.

# Case 2: Chances of Violating SLA by Monte Carlo Simulation

- Snow, A. and Weckman G., *What are the chances of violating an availability SLA?*, International Conference on Networking 2008 (ICN08), April 2008.
- Gupta, V., *Probability of SLA Violation for Semi-Markov Availability*, Masters Thesis, Ohio University, March 2009.

# What's an SLA?

- Contractual agreement between a service provider and a customer buying a service
- Agreement stipulates some minimum QOS requirement
  - Latency, throughput, availability.....
- Can have incentives or disincentives:
  - Partial payback of service fees for not meeting QOS objectives in agreement
- Example of (service provider, customer)
  - (Carrier Service, Insurance company)
  - Frame Relay Services
  - VPN Services
  - CENTREX
  - Leased Line (e.g., T/E-1, T/E-3, OC-XX)

# Who Cares About Availability?

- Who Cares About Availability?
  - End Users of systems/services
  - Providers of systems/services
- When a system/service is not available, customers could suffer:
  - Inconvenience
  - Lost revenue/profit
  - Decreased safety

# Availability Distribution

- Availability is a function of MTTF and MTTR
- MTTF is the arithmetic mean of TTFs, which are random variables
- MTTR is the arithmetic mean of TTRs, which are random variables
- As availability is a function of MTTF and MTTR, its distribution is complex



# What is the problem with a mean?

- As Availability is made up of means, it too is a mean
- The “Holy Grail” for Availability is often:
  - “Five Nines”, or
  - $0.99999 = 99.999\%$
  - Power System, T/E-3 digital link, etc.
- What is the problem with a mean?

# More than One Way to Meet an Interval Availability Goal of 5-Nines

- For a given Availability goal, many combinations of *MTTF* & *MTTR* produce the same availability

<u>AVAILABILITY</u>	<u>MTTF (Yr)</u>	<u>MTTR (Min)</u>
0.99999	0.5	2.63
0.99999	1	5.26
0.99999	2	10.51
0.99999	3	15.77
0.99999	4	21.02
0.99999	5	26.28
0.99999	6	31.54
0.99999	7	36.79
0.99999	8	42.05

- However the spread for an average Availability is different for different combinations of *MTTF* and *MTTR*

# What we investigated

- Markov Availability
  - Exponential arrival of failures and independence of failures (HHP)
  - Exponential repair time
- Semi-Markov Availability
  - Exponential arrival of failures and independence of failures (HHP)
  - Nonexponential repair
    - Used Lognormal distribution (short and long tail)

# Research Methodology

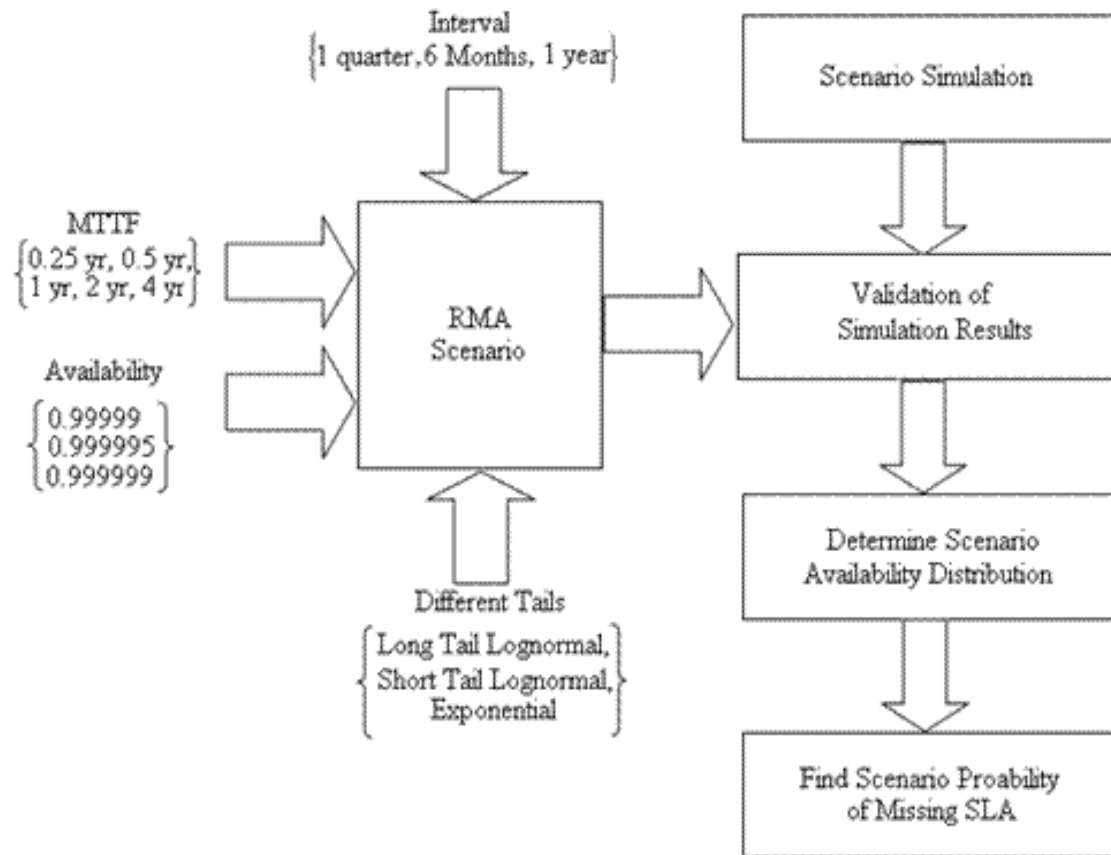

Gupta, V., Probability of SLA Violation for Semi-Markov Availability, Masters Thesis, Ohio University, March 2009.

# Monte Carlo Simulation Methodology

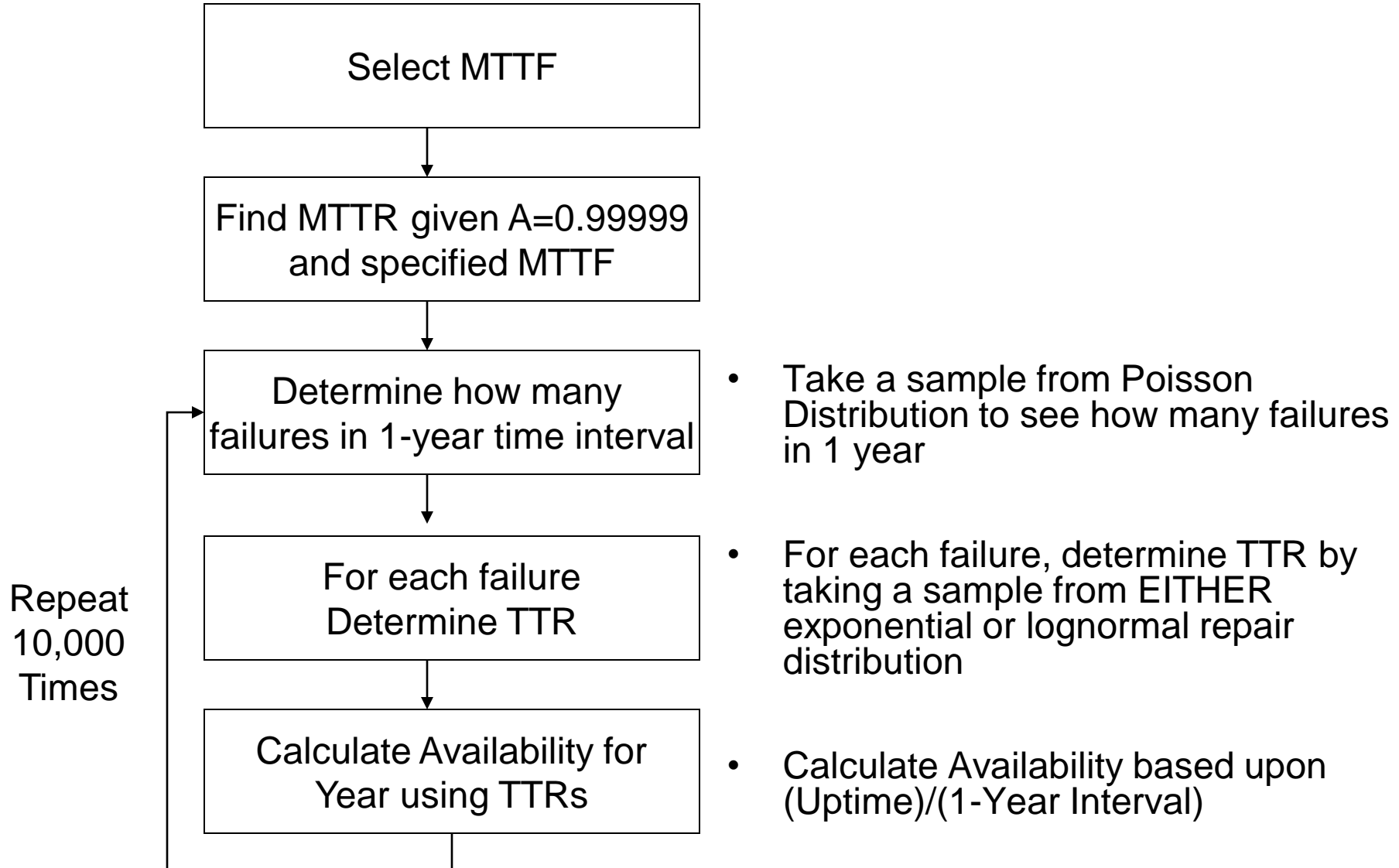

# Cumulative Distribution Function

MTTF = 4 Yr; MTTR = 21.02 min; TI = 1 Yr

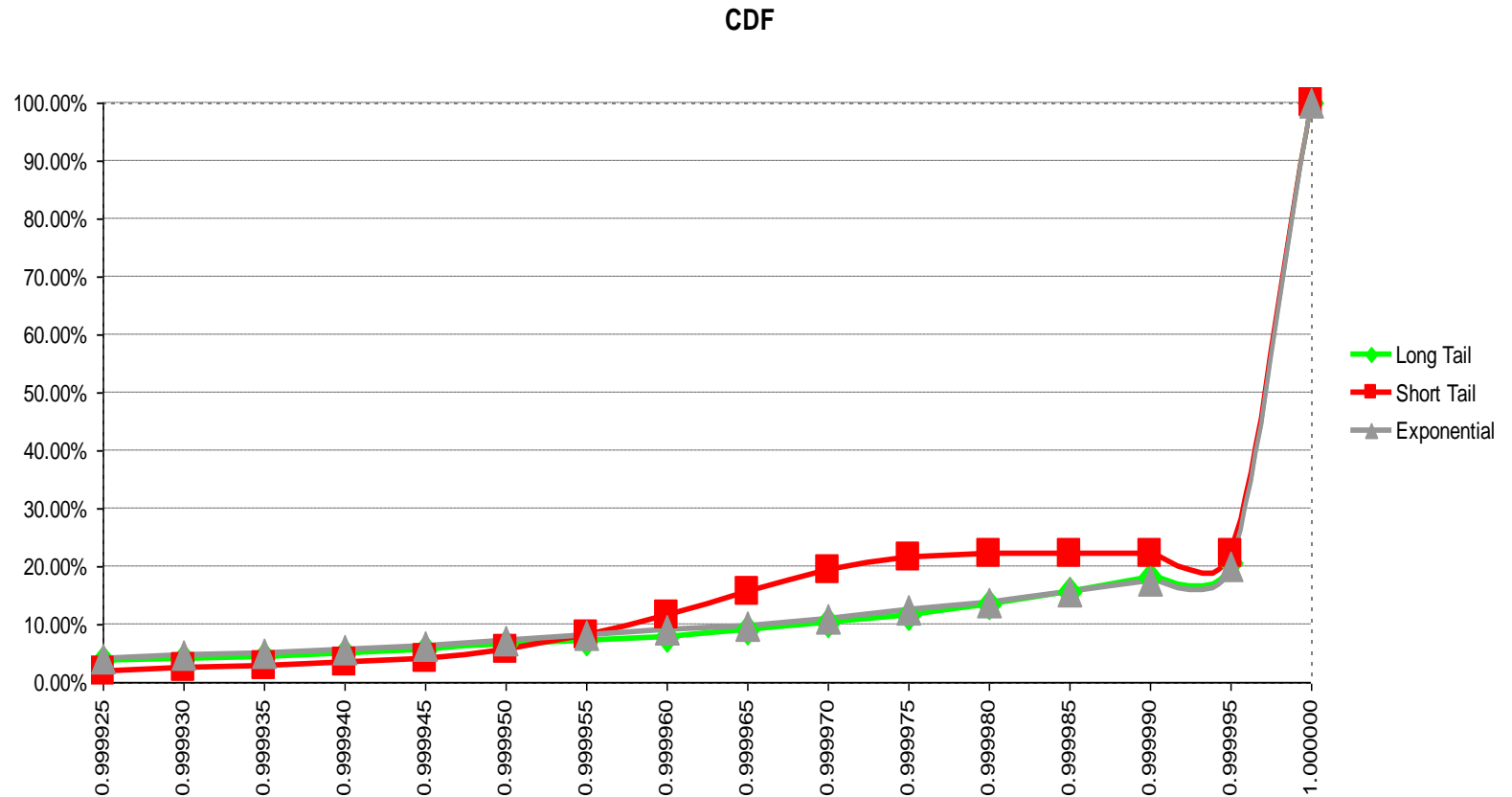

# Conditional Cumulative Distribution Function

MTTF = 4 Yr; MTTR = 21.02 min; TI = 1 Yr

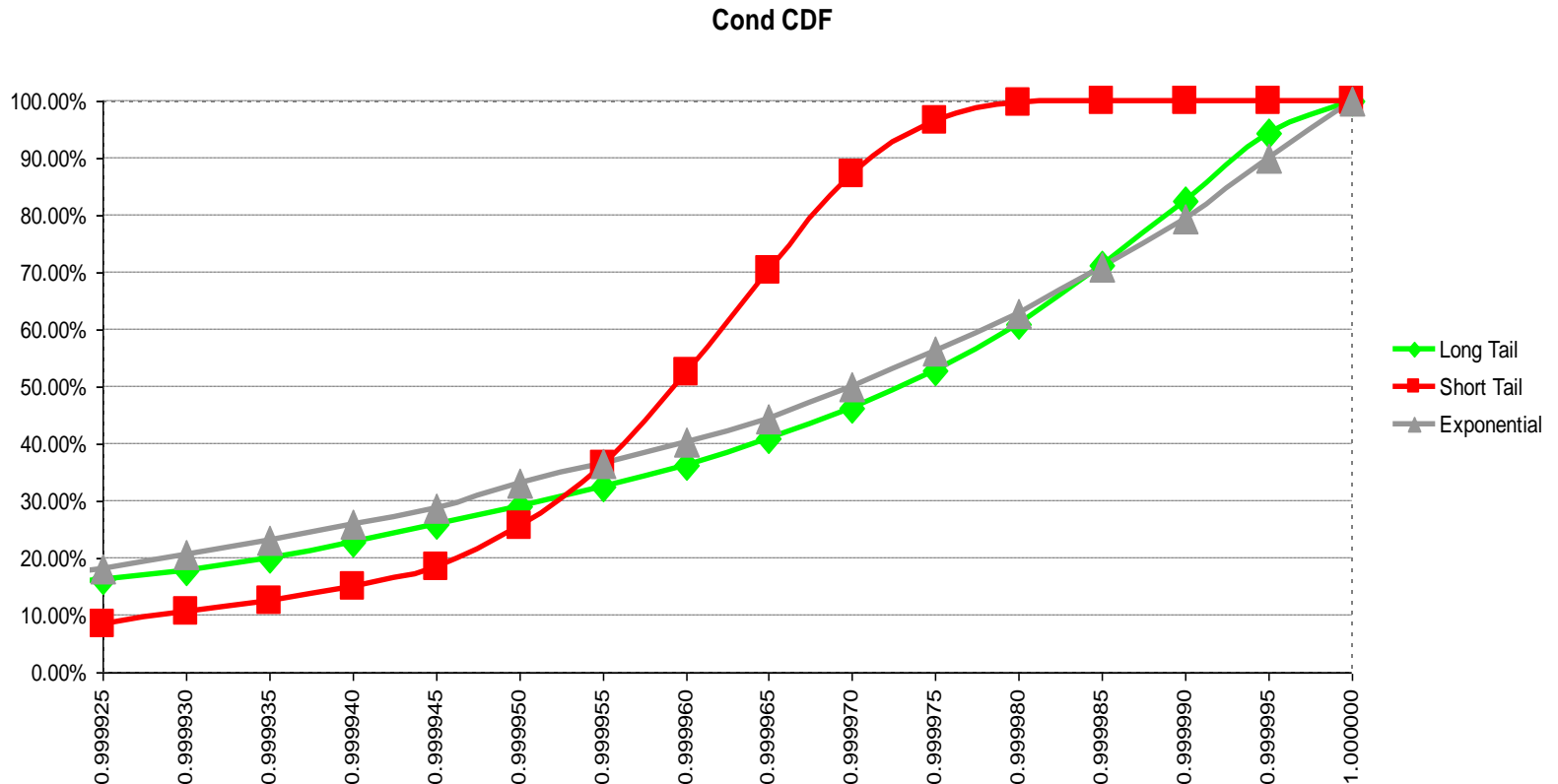

# Cumulative Distribution Function MTTF = 4 Yr

MTTR = 20.6 min; TI = 1 YR; A= 0.999999

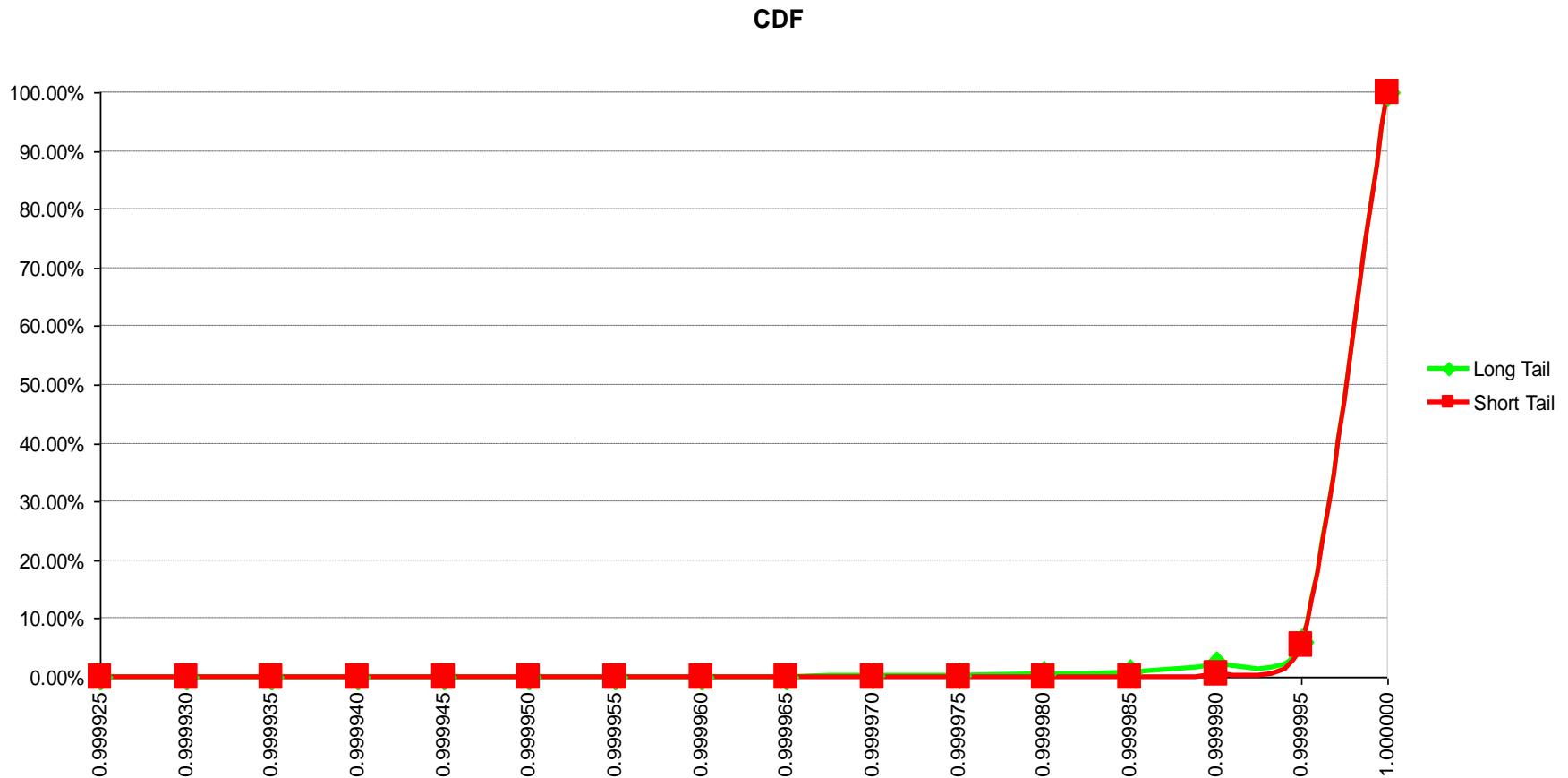



# Conditional Cumulative Distribution Function

MTTF = 4 Yr; MTTR = 20.6 min;

TI = 1 YR; A= 0.999999

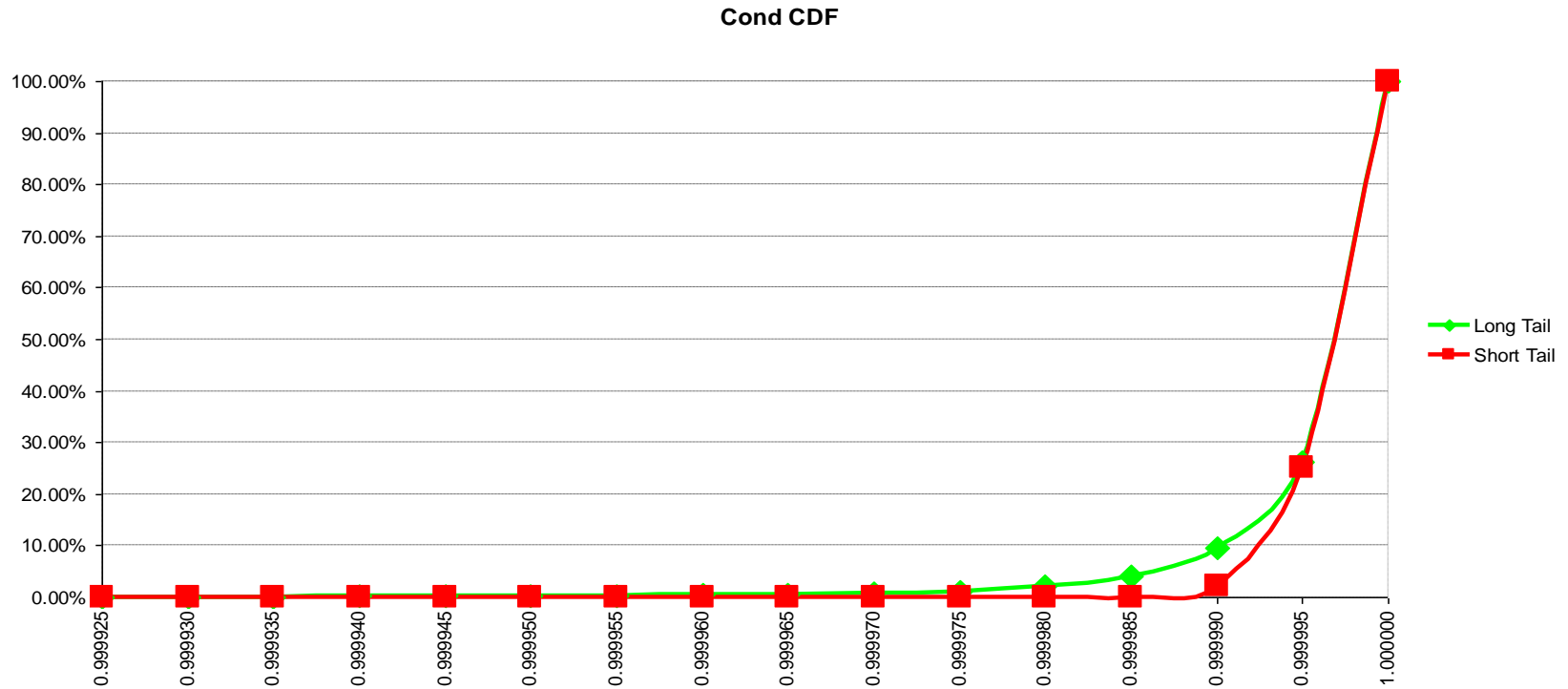

# Long Tail Lognormal Distribution

## TI = 1 YR; A = 0.99999

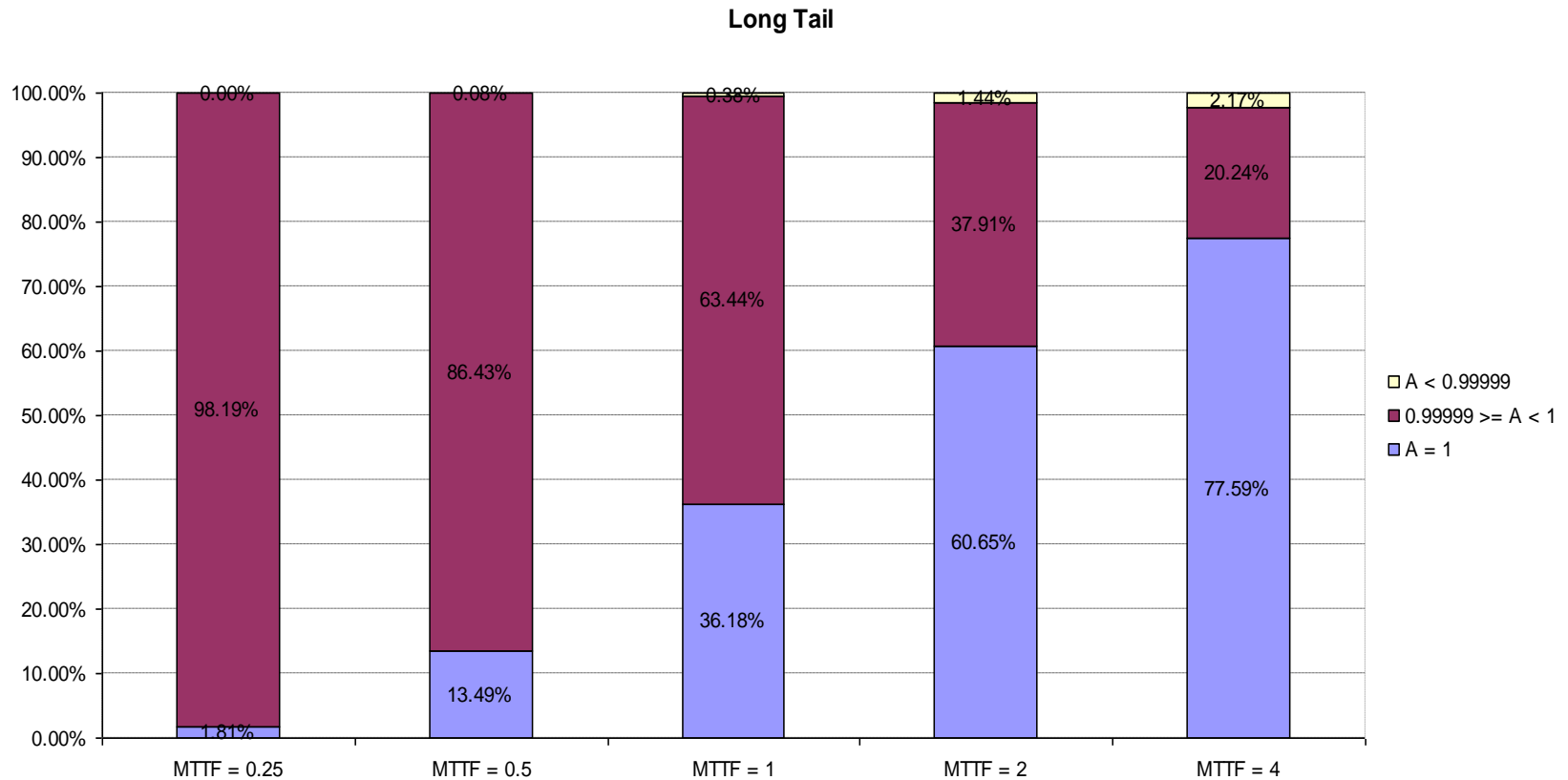

# Conditional Long Tail Lognormal Distribution

TI = 1 YR; A = 0.999999

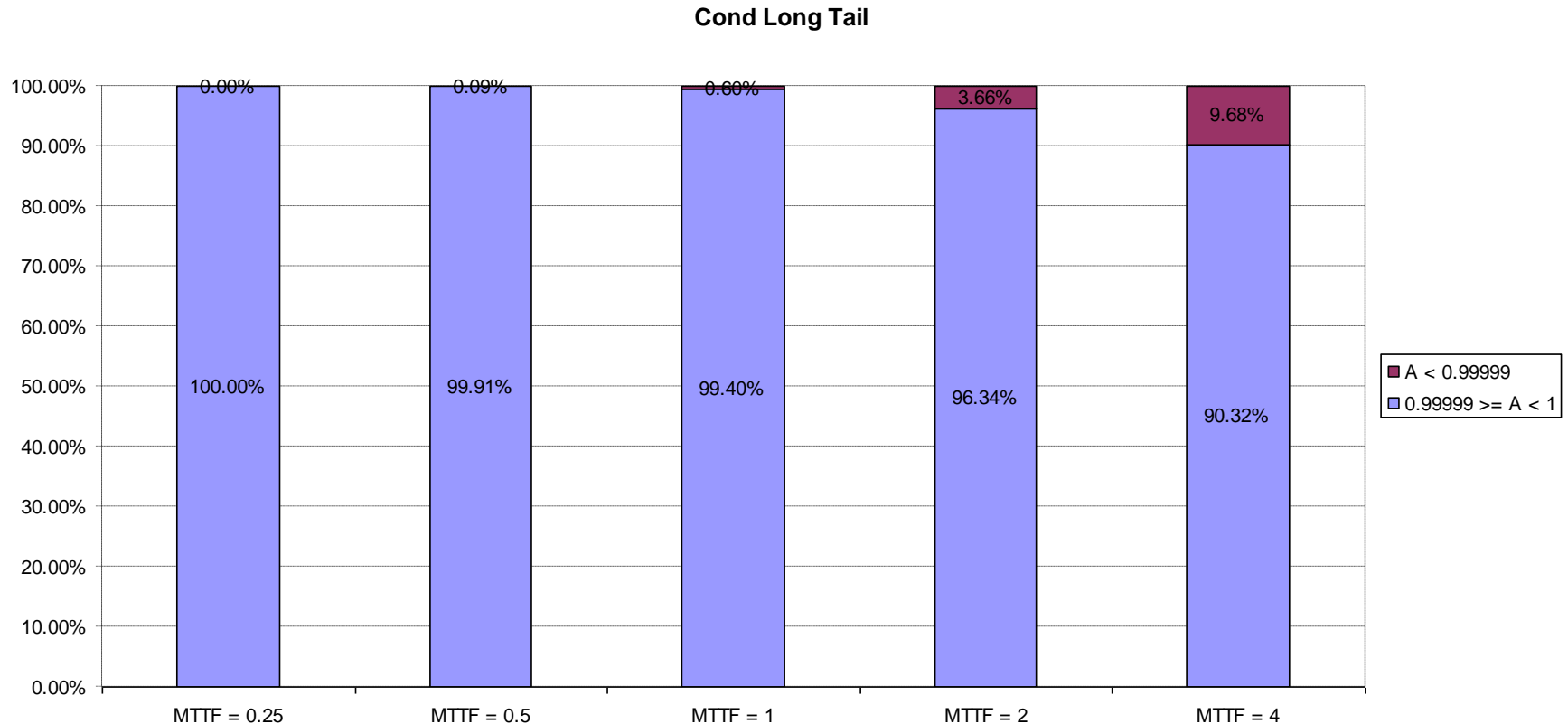

# Some Conclusions

- Pr {SLA violation} for 5-nines is fairly insensitive to the long tail and short tail distributions studied
  - Largest difference found due to distribution about 5%
  - Exponential repair distribution pretty safe assumption
- High reliability scenarios depend upon no failures in interval to meet 5-nines SLA
  - If there is a failure in interval, SLA missed majority of time
- The shorter the interval, the less chance of violating 5-nines SLA, e.g. for MTTF 4 years:
  - Interval  $\frac{1}{4}$  year: Pr {SLA violation} about 5%
  - Interval  $\frac{1}{2}$  year: Pr {SLA violation} about 9-12%
  - Interval 1 year: Pr {SLA violation} about 17-22%

# Some Conclusions (Continued)

- Availability engineering margin
  - Engineered availability of 6-nines to meet a 5-nines objective
  - For the cases investigated drives  $\text{Pr}\{\text{SLA Violation}\}$  to 2% or less
  - Essentially removes distribution tail as a  $\text{Pr}\{\text{SLA Violation}\}$  factor
  - Even if there is a failure, maintenance ensures 5-nines objective met almost all the time
- When someone is selling/buying an Availability SLA, it is good to know
  - The availability engineering margin
  - How much the service provider is depending upon no failures<sup>1</sup>
  - Actual MTTR statistics

<sup>1</sup> Based upon statistics anonymously passed to author, recovery time for a DS3 circuit was reported to be about 3.5 hours

# Case 3: TCOM Power Outage Assessment by Poisson Regression & RCA

- “Modeling Telecommunication Outages Due To Power Loss”, by Andrew P. Snow, Gary R. Weckman, and Kavitha Chayanam
- “Power Related Network Outages: Impact, Triggering Events, And Root Causes”, by A. Snow, K. Chatanyam, G. Weckman, and P. Campbell

# Introduction

- Management must include the ability to monitor the AC and DC power capabilities necessary to run the network.
- Large scale networks, communication facility power is often triply redundant
- In spite of significant redundancy, loss of power to communications equipment affects millions of telecommunications subscribers per Year
- This is an empirical study of 150 large-scale telecommunications outages reported by carriers to the Federal Communications Commission, occurring in the US over an 8 year period
  - Data includes the date/time of each outage, allowing time series reliability analysis

# Overview

- Reasons of loss of power to communications equipment
- This study analyzes this special class of telecommunications outages over an 8-year period (1996 through 2003) and is based on information found in outage reports to the FCC
  - Involve the failure of a number of redundant power systems
  - Sequential events leading to the complete power failure
    - better understanding of root causes
- During the 8-year study period:
  - 1,557 FCC reportable outages
  - About 10% of the cases, the outage resulted because of loss of power
- This study considers:
  - 150 outages in which the service disruption was caused by loss of power to communications equipment and will be referred to as 'Power outages'



# Power Wiring Diagram

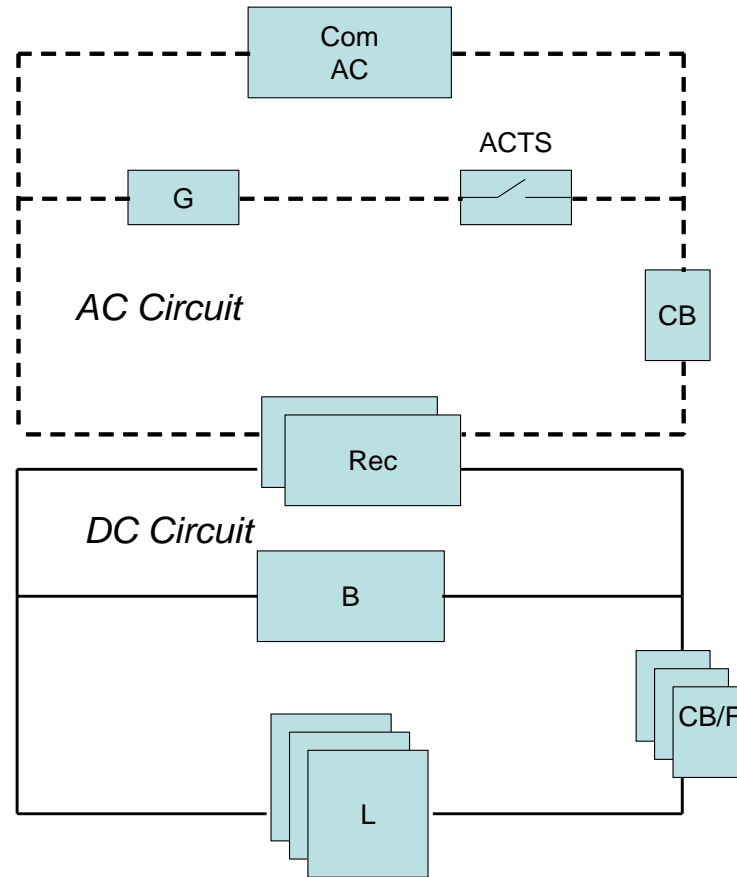

Com AC: Commercial AC      Rec: Rectifiers  
G: Generator                      B: Batteries  
ACTS: AC Transfer Switch      CB/F: DC Ckt Breakers/Fuses  
CB: Main Circuit Breaker      L: Communication Load

# METHODOLOGY

- A nonhomogeneous Poisson process (NHPP) is often suggested as an appropriate model for a system whose failure rate varies over time
  - In the early years of development the term “learning curve” was used to explain the model’s concepts, rather than “reliability growth”. J. T. Duane presented his initial findings as a “Learning Curve approach to Reliability Monitoring”
  - Duane (1964) first introduced the power law model for decreasing failure point processes
- In addition to the power law, another technique for modeling reliability growth is by breakpoint analysis
  - Breakpoint reliability processes have previously shown up in large-scale telecommunications networks

# Power Outage Count per Quarter for an Eight Year Study Period

Quarter	Count	Quarter	Count	Quarter	Count	Quarter	Count
1 (1 <sup>st</sup> Q 96)	5	9 (1 <sup>st</sup> Q 98)	2	17 (1 <sup>st</sup> Q 00)	8	25 (1 <sup>st</sup> Q 02)	5
2 (2 <sup>nd</sup> Q 96)	7	10 (2 <sup>nd</sup> Q 98)	11	18 (2 <sup>nd</sup> Q 00)	4	26 (2 <sup>nd</sup> Q 02)	2
3 (3 <sup>rd</sup> Q 96)	5	11 (3 <sup>rd</sup> Q 98)	5	19 (3 <sup>rd</sup> Q 00)	6	27 (3 <sup>rd</sup> Q 02)	1
4 (4 <sup>th</sup> Q 96)	2	12 (4 <sup>th</sup> Q 98)	4	20 (4 <sup>th</sup> Q 00)	9	28 (4 <sup>th</sup> Q 02)	0
5 (1 <sup>st</sup> Q 97)	5	13 (1 <sup>st</sup> Q 99)	1	21 (1 <sup>st</sup> Q 01)	3	29 (1 <sup>st</sup> Q 03)	0
6 (2 <sup>nd</sup> Q 97)	11	14 (2 <sup>nd</sup> Q 99)	8	22 (2 <sup>nd</sup> Q 01)	5	30 (2 <sup>nd</sup> Q 03)	2
7 (3 <sup>rd</sup> Q 97)	6	15 (3 <sup>rd</sup> Q 99)	7	23 (3 <sup>rd</sup> Q 01)	9	31 (3 <sup>rd</sup> Q 03)	10
8 (4 <sup>th</sup> Q 97)	2	16 (4 <sup>th</sup> Q 99)	4	24 (4 <sup>th</sup> Q 01)	1	32 (4 <sup>th</sup> Q 03)	0

# Power Outage Cumulative Quarterly Count

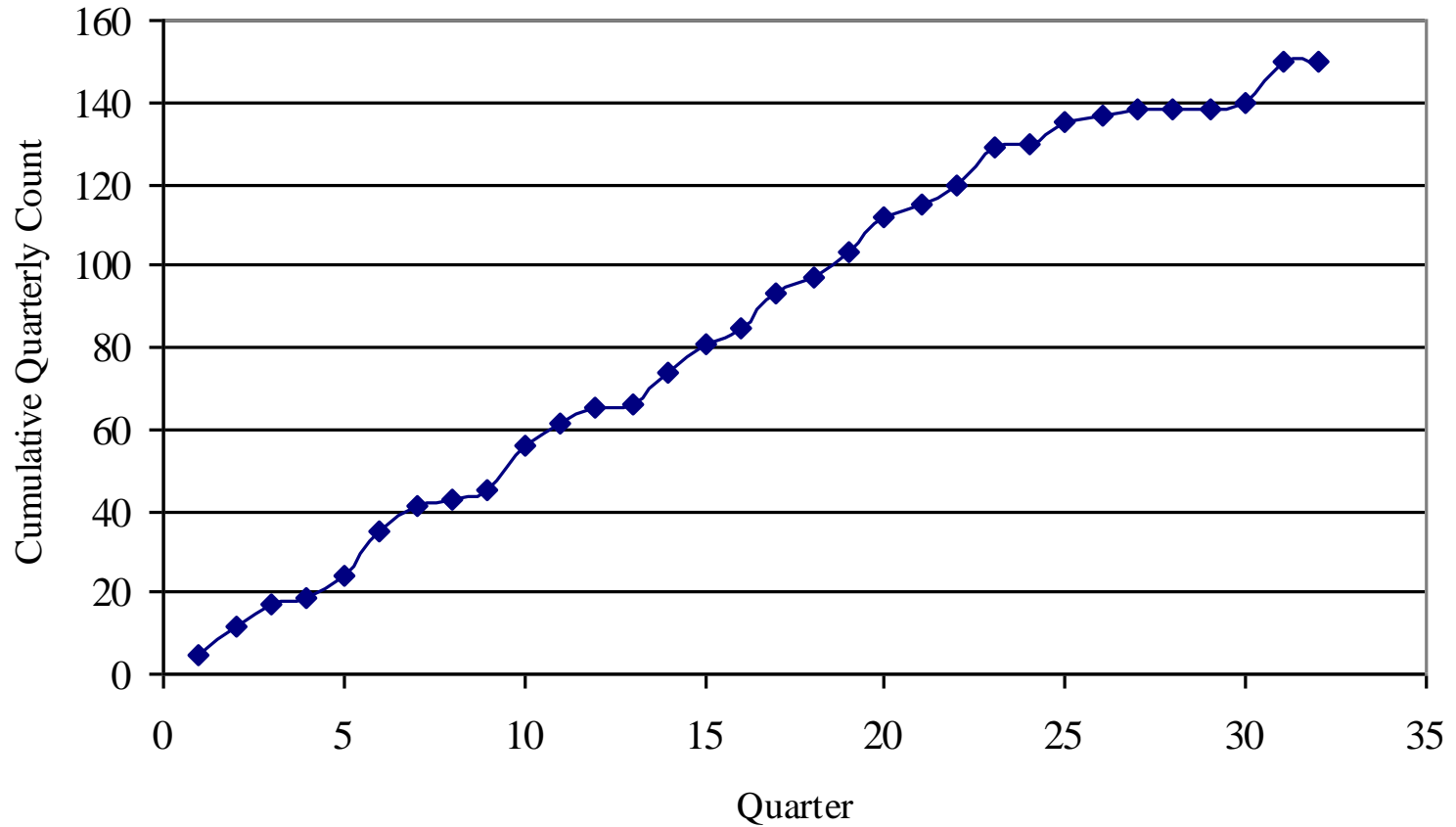

# Power Law Model

- The Power Law Model is also called the Weibull Reliability Growth Model (Asher and Feingold, 1984)
- Commonly used infinite failure model, which shows monotonic increase or decay in events.
- This process is a NHPP

# Piecewise Linear Model

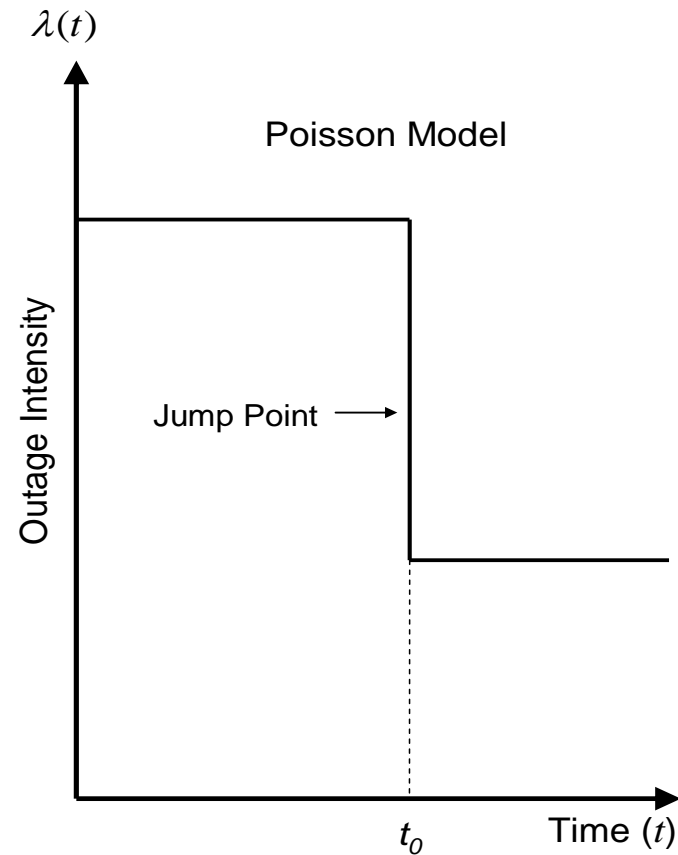
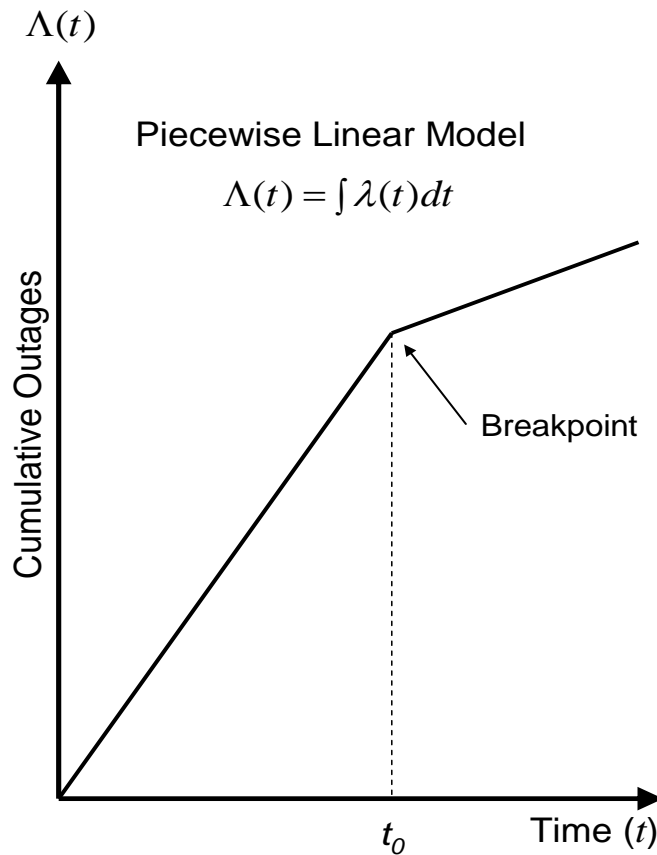

# Comparison of Power Law Model and Cumulative Outage Data

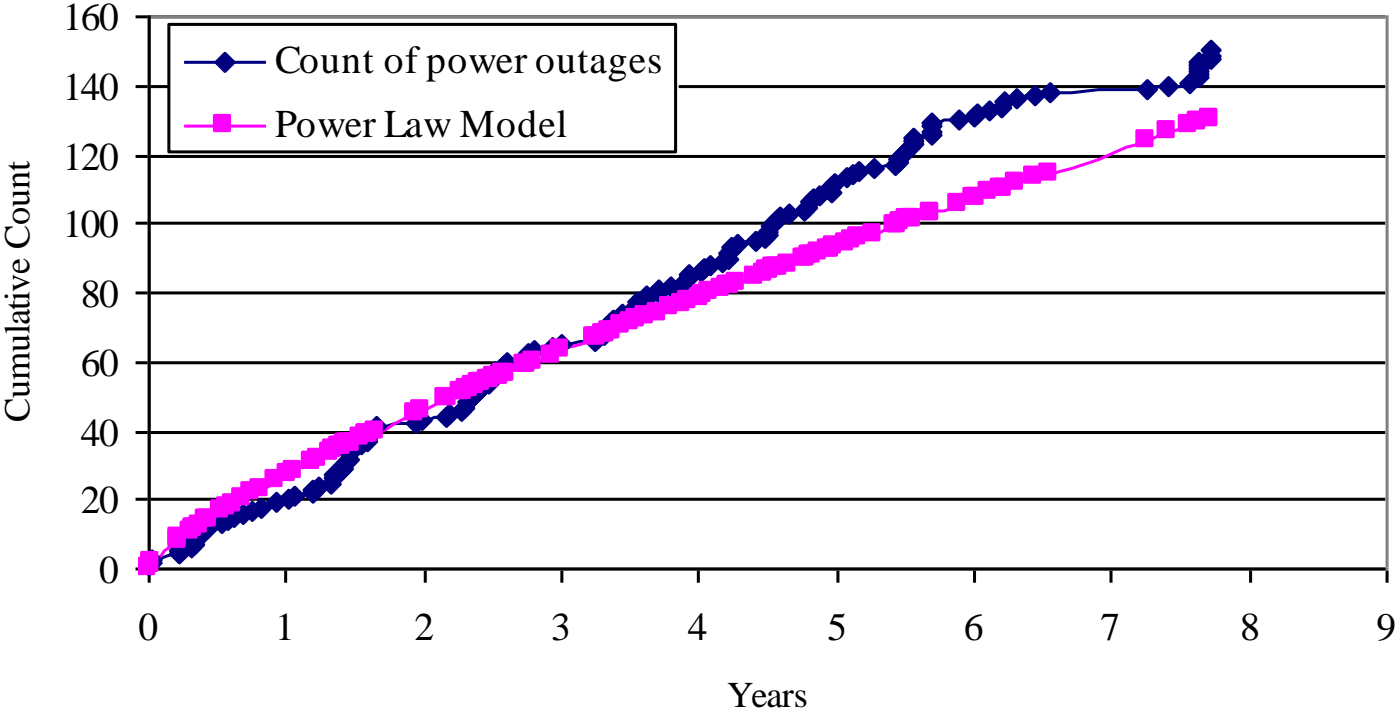

# Comparison of Piecewise Linear Model and Cumulative Outage Count

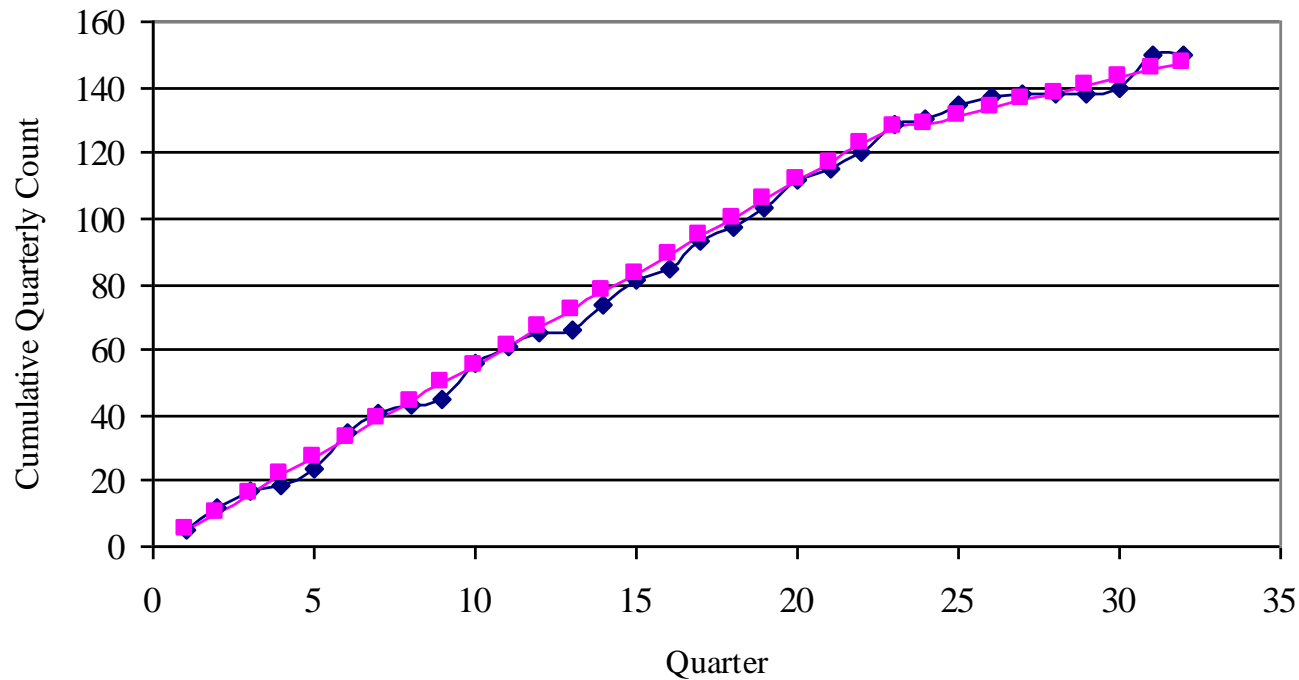



# Comparison of Jump Point Model to Quarterly Outage Count

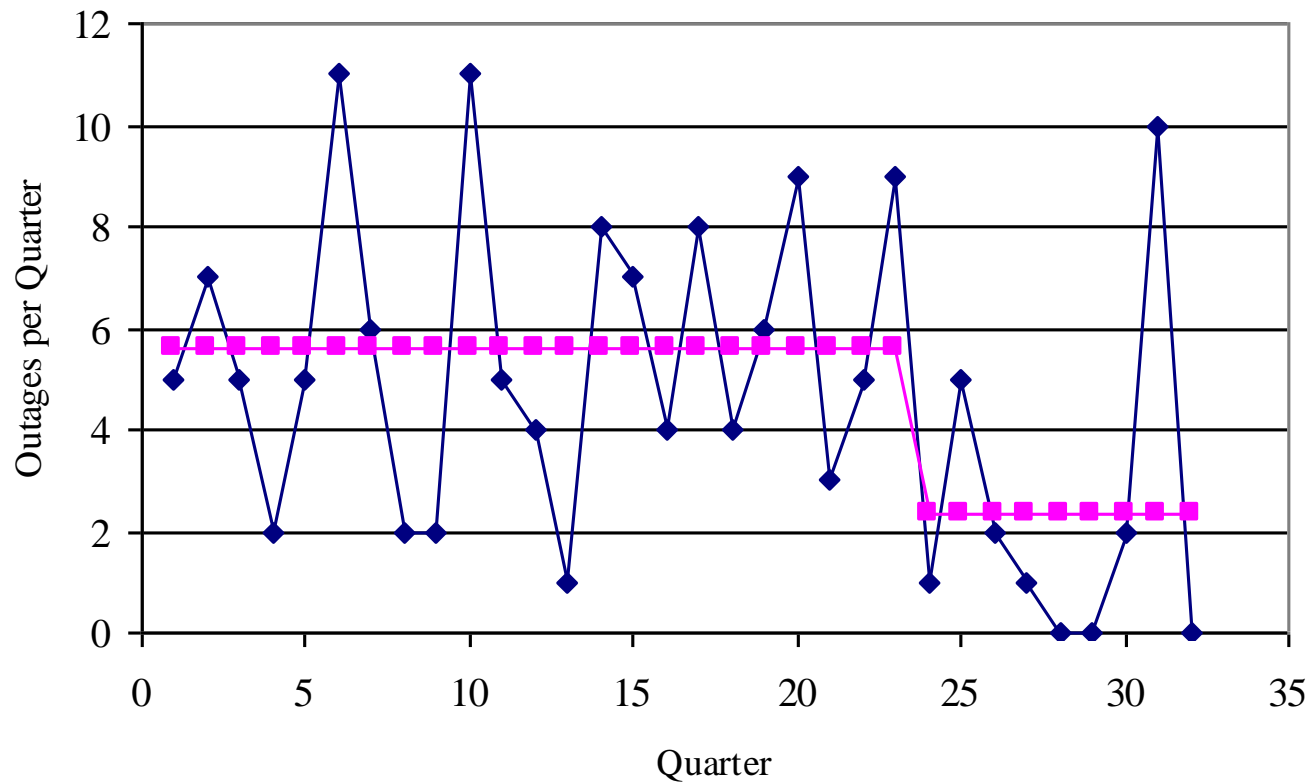

# CONCLUSIONS

- Little evidence of a seasonal effect
  - Not unusual as every commercial power outage does not result in a telecommunications power outage because of backup power sources (generator and batteries)
  - hazards that take down commercial power occur throughout the year
- The Laplace Trend Test indicated strong statistical evidence of reliability growth
  - Reliability growth was not monotonic as evidenced by a poor fit to the power law model
  - Evidence for continuous improvement was lacking.
- Evidence for reliability growth occurring after 9-11 is strong
  - The piecewise linear model with a rate change jump point is the best reliability growth model found
  - Clearly indicates two distinct processes with constant reliability, yet improvement after the 9-11 attack.

# CONCLUSIONS

- It appears that 9-11 was episodic, with telecommunications carrier management and engineers focusing more closely on the reliability of critical infrastructures.
- At this point, it is not known what proportions of this improvement are due to improved engineering, operational, or maintenance processes
  - The abrupt improvement is highly suggestive of operational and maintenance efforts.
  - Perhaps 9-11 served as a wakeup call for service providers when it comes to business and service continuity? Time will tell.

# OUTAGE CAUSES

- Trigger cause
  - event that initiates the sequence that finally resulted in the outage
- Direct cause
  - final event in the sequence of events that lead to the outage
- Root cause
  - gives an insight of why the outage occurred, and how to avoid such outages in the future
  - technique called Root Cause Analysis (RCA) [14].

# Reliability Diagram with Failure Sequence

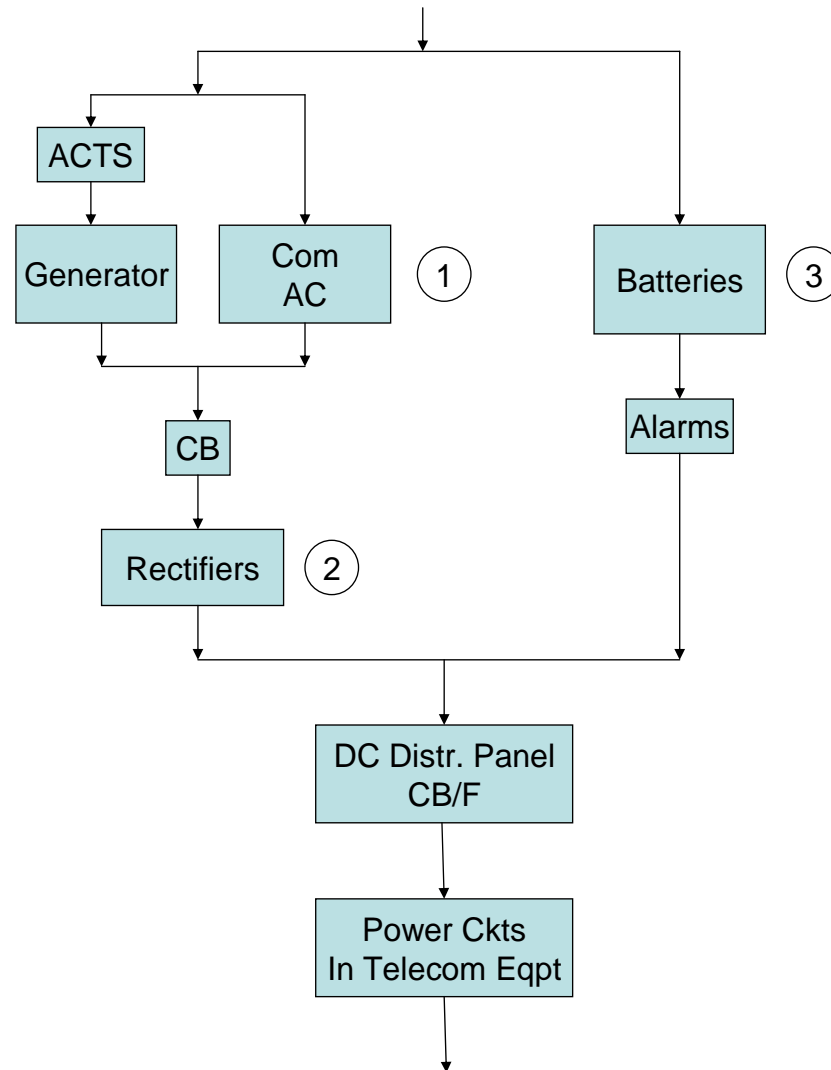

# Root Cause Analyses: sample outages

**Example 1:** A lightning strike resulted in a commercial AC power surge, causing the rectifier AC circuit breakers to trip open. This means that AC from either the primary or backup source cannot be converted to DC. As a consequence, the batteries must supply power until the rectifiers are manually switched back on line. The alarm system does not work properly, and the NOC is not notified of the problem. After some time the batteries are exhausted and the communications equipment loses power, and an outage occurs.

- Trigger Cause: Lightning strike.
- Direct Cause: Battery Depletion.
- Root Cause: Maintenance -- Failure to test alarm system.

# Root Cause Analyses: sample outages

**Example 2:** Torrential rains and flooding due to a tropical storm in Houston causes commercial AC power failure. The generators in the communication complexes are supplied with fuel from supply pumps that are located in the basement of the building. Due to the flooding, water entered the basement causing supply pump failure. Hence, the generators ran out of fuel, and the facility goes on battery power. After some time, the batteries stopped supplying power to the equipment thus resulting in an outage.

- Trigger Cause: Storms (Flooding).
- Direct Cause: Battery depletion.
- Root Cause: Engineering failure (The fuel pump system was placed in the basement in an area prone to flooding).

# Root Cause Analyses: sample outages

**Example 3:** A wrench dropped by a maintenance worker landed on an exposed DC power bus which shorted out. Exposed power buses should be covered before maintenance activity starts. Maintenance personnel error can be reduced by providing sufficient training to personnel.

- Trigger Cause: Dropping a tool.
- Direct Cause: DC short circuit.
- Root Cause: Human error



# Impact of Outages Studied (Trigger and Root Causes)

Impact Category	Lost Customer Hours (LCH) In Thousands	Number of Outages
Low	LCH < 250	89
Medium	250 LCH < 1,000	30
High	1,000	31

Trigger Cause	Total Outages	Low Impact	Medium Impact	High Impact
Natural Disasters	14 %	8 %	16 %	29 %
Power Surges	18 %	23 %	10 %	13 %
Comm. AC Loss	38 %	39 %	37 %	35 %
Human Errors	30 %	30 %	37 %	23 %
<b>Total</b>	<b>100 %</b>	<b>100 %</b>	<b>100 %</b>	<b>100 %</b>

Root Cause	Total Outages	Low Impact	Medium Impact	High Impact
Engn. Error	2 %	4 %	3 %	35 %
Install. Error	23 %	27 %	27 %	10 %
Opns. Error	33 %	37 %	33 %	23 %
Maint. Error	27 %	26 %	37 %	23 %
Unforeseen	5 %	6 %	0.0 %	10 %
<b>Total</b>	<b>100%</b>	<b>100%</b>	<b>100%</b>	<b>100%</b>

# Power Component Associated with Root Cause

## Root Cause Power Component Distribution

Component	Total Outages	Low Impact	Med. Impact	High Impact
Rectifiers	14%	9%	20%	23%
Batteries	13%	9%	23%	16%
Generators	18%	16%	13%	29%
AC Cir. Breakers	20%	23%	17%	16%
Comm. Equip.	12%	15%	10%	7%
DC Fuse/CB	10%	13%	8%	6%
Comm. AC	2%	3%	0%	0%
AC Trans Switch	3%	3%	3%	0%
Alarm Systems	7%	9%	3%	3%
Environ. Systems	1%	0%	3%	0%
<b>Total</b>	<b>100%</b>	<b>100%</b>	<b>100%</b>	<b>100%</b>

Component	Example
Rectifiers	<ol style="list-style-type: none"> <li>1. Power surge, due to lightning strike.</li> <li>2. Rectifiers damaged, batteries not charged.</li> <li>3. Batteries eventually exhausted.</li> </ol>
Batteries	<ol style="list-style-type: none"> <li>1. Loss of commercial AC.</li> <li>2. Batteries failed because of loose battery cell strings.</li> </ol>
Environmental Systems	<ol style="list-style-type: none"> <li>1. Loss of commercial AC.</li> <li>2. Generator started running.</li> <li>3. Failure of Air Conditioning system.</li> <li>4. Generator overheated and stopped.</li> </ol>
Circuit Breakers	<ol style="list-style-type: none"> <li>1. Loss of commercial AC.</li> <li>2. Main Circuit breaker opens due to an AC power surge.</li> <li>3. Site is supplied power from batteries.</li> <li>4. Batteries eventually exhausted.</li> </ol>
Generators	<ol style="list-style-type: none"> <li>1. Loss of commercial AC.</li> <li>2. Generator started but stopped after some time due to piston seizure, contaminated fuel, or runs out of fuel.</li> <li>3. Batteries supply power until finally exhausted.</li> </ol>
Alarm System	<ol style="list-style-type: none"> <li>1. Loss of commercial AC.</li> <li>2. Generator started to run but stopped due to overheating.</li> <li>3. Alarm system failed to generate an alarm at NOC.</li> <li>4. Site runs on batteries until exhausted.</li> </ol>
AC Transfer Switch	<ol style="list-style-type: none"> <li>1. Loss of commercial AC.</li> <li>2. Failure of AC transfer switch.</li> <li>3. Site is left on batteries until exhausted.</li> </ol>
Communications Equip.	<ol style="list-style-type: none"> <li>1. Technician working on the communications equipment drops tool shorting DC bus on equipment.</li> <li>2. Equipment shutdown.</li> </ol>
DC Fuse/CB	<ol style="list-style-type: none"> <li>1. Fuses to telecommunications equipment blow since they were drawing more current than their rated specifications.</li> <li>2. Equipment Shutdown.</li> </ol>
Commercial AC	<ol style="list-style-type: none"> <li>1. Some outages occurred due to the loss of Commercial AC.</li> <li>2. No information given about the series of events in report.</li> </ol>

# CONCLUSIONS

- The trigger, root cause, and equipment most associated with the root cause, have been examined by outage impact for telecommunications power outages over an eight year period
- This analysis has provided insights into these outages, and should be of interest to carriers, regulators, and Homeland Security
- There are two aspects of these results:
  - Proactive
    - Carrier industry adoption of NRIC Best Practices can go a long way to prevent such outages;
    - Following best practices could have prevented 75% of the outages.
    - The other 25% could not be determined from the reports.
  - Reactive
    - An emphasis on rectifier and generator recovery (e.g. spare parts, training, etc.) can help, as over half of high impact outages are due to problems with these components.

# Case 4: SS7 Outages Assessment by Poisson Regression & RCA

“A Pre And Post 9-11 Analysis Of SS7 Outages In The Public Switched Telephone Network” by Garima Bajaj, Andrew P. Snow and Gary Weckman

# Reliability Poisson model for all FCC-Large Scale Reportable Outages 1993-2004

## Jump point model

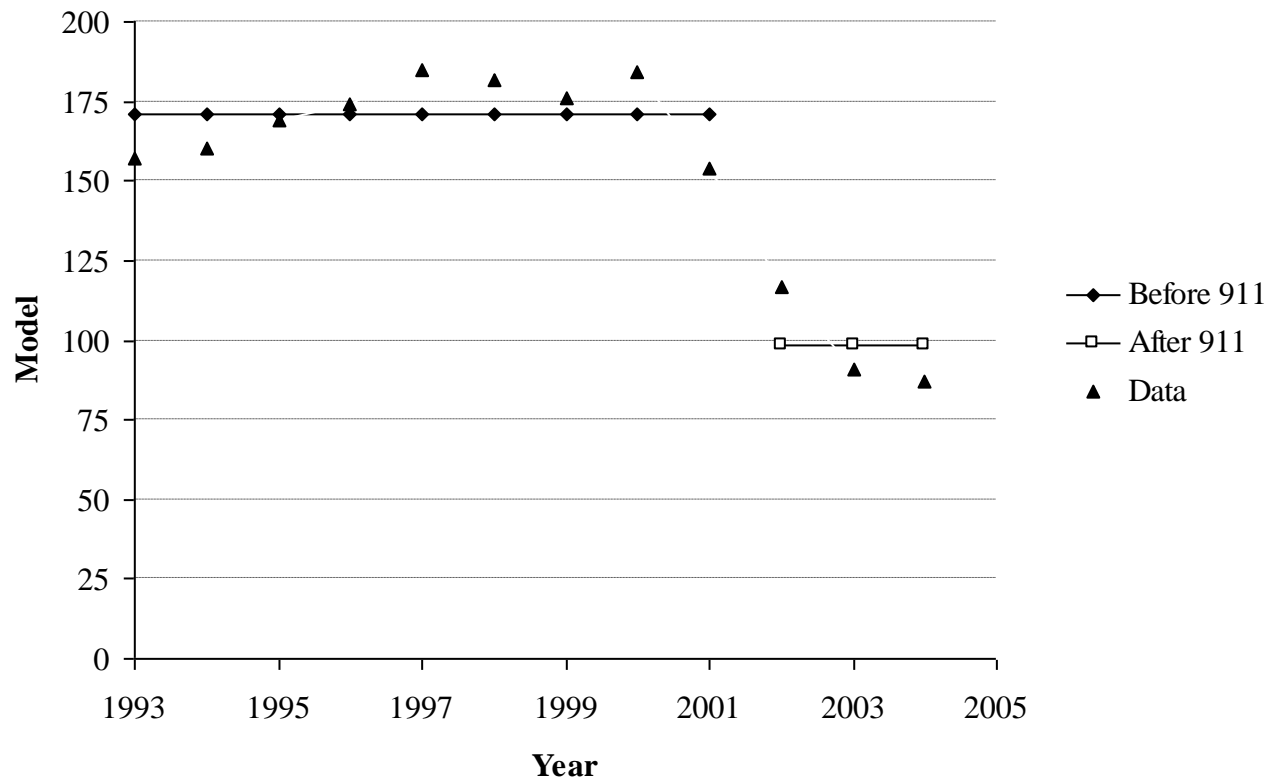

# Introduction

- The purpose of this work is to identify any reliability and causality differences in Signaling System No. 7 (SS7) outages before and after 9-11.
- This research addresses questions related to differences in outage frequency, time of day, day of week, and causes in pre and post 9-11 outage events.
- Work consists of trend testing, model building, descriptive statistics, mean tests, temporal analysis, and causality analysis.
- From the analysis it was found that SS7 outage frequency decreased by 60% after 9-11, indicating reliability growth.
- Some significant differences in trigger, direct and root causality were also observed.
- The largest direct cause of SS7 network isolation from local and tandem switches was loss of A-links due to human activity, with the root cause being diversity deficits.

# Scope of research

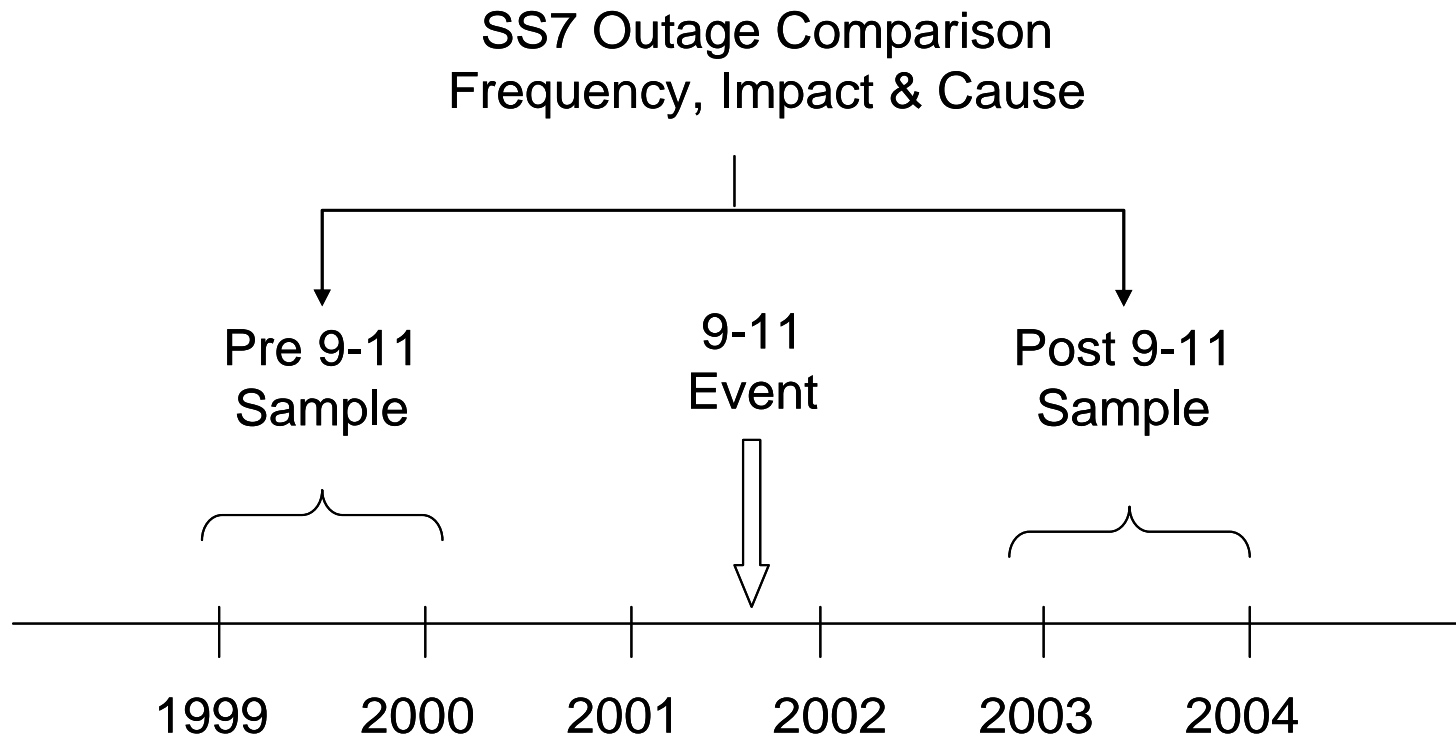

# Outage sampling

- A convenience sampling technique was used to sample the SS7 outage data before and after 9-11.
- Comparisons were made between FCC SS7 outage reports in 1999-2000 against all in 2003-2004.
  - One factor in this selection was that the FCC reports after 2004 are not accessible to public.
  - However, the primary reason was to temporally balance the samples and avoid potential years where process change might occur abruptly
  - The data sets were created for separate analysis.
  - Analyzing and comparing these two data sets provides useful insights into the effect the 9-11 event might have had on telecommunication industry and society.
- After sampling the data, all the FCC-Reportable outage reports involving SS7 outages were selected.
  - After reviewing all the FCC reports for 1999-2000 and 2003-2004, 145 out of 689 reports involved SS7 outages.
  - Report data comprised of the following variables: Outage date, Outage time in EST, Number of customers affected, Blocked calls, Duration in minutes, and Total number customers affected.
  - Data associated with all these variables were collected directly from each outage report)



# SS7 Architecture

SS7 Architecture

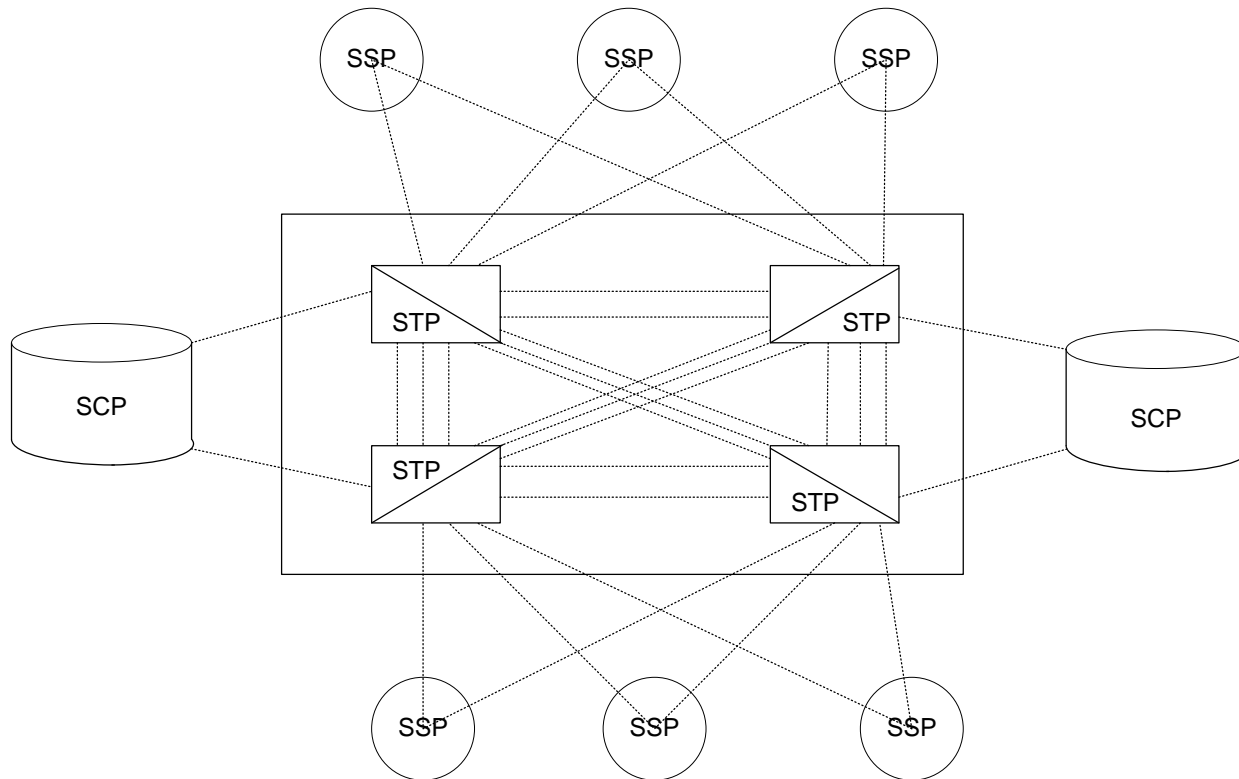

# Total outages vs. SS7 Outages

## SS7 outages before and after 911

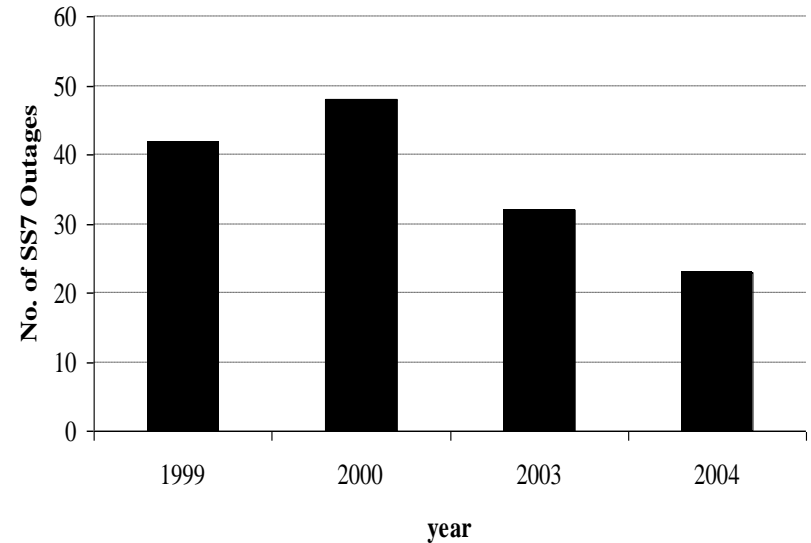
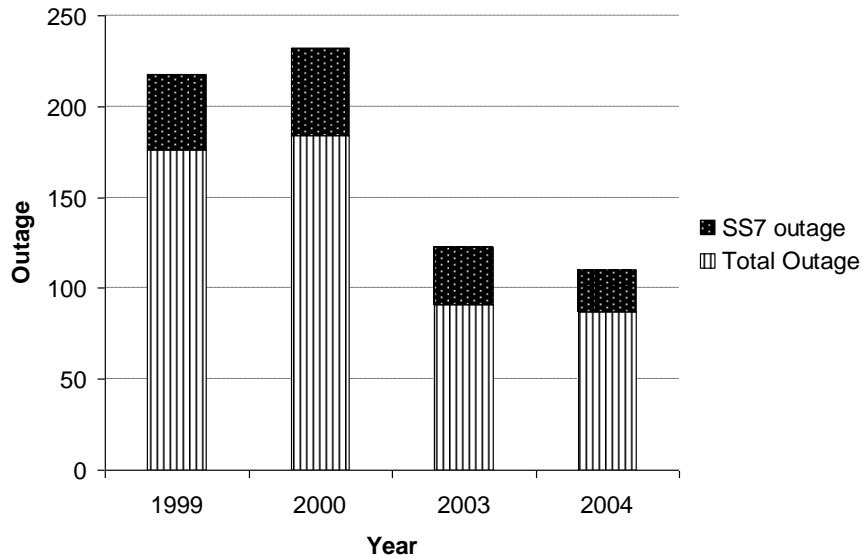

# Cumulative SS7 outages

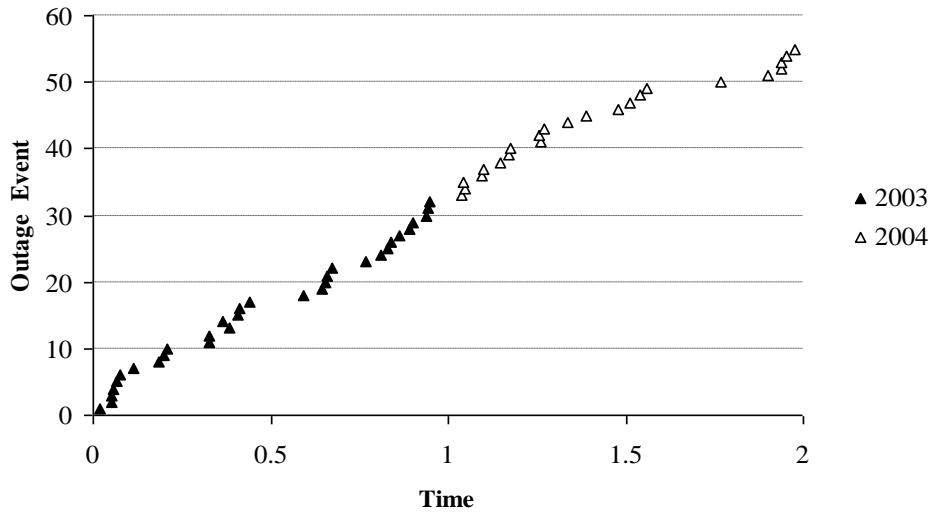
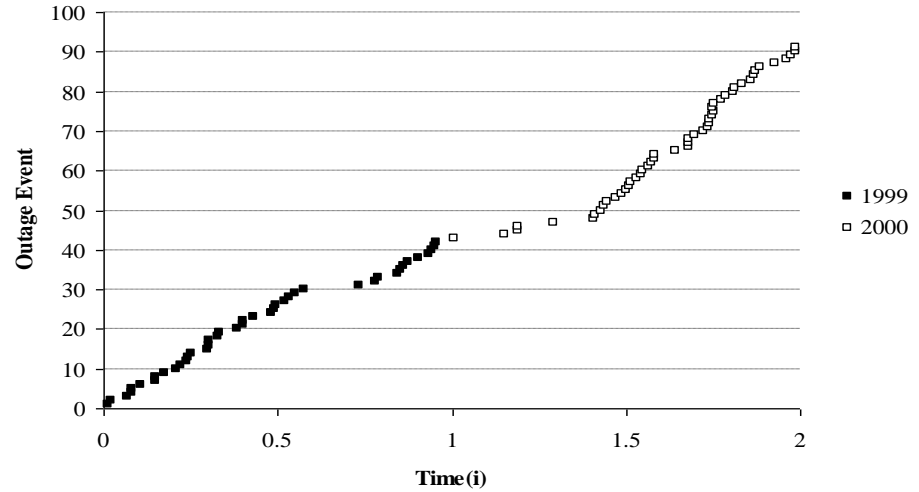

# Trigger Causes

- **Fiber Cut:** Fiber cut involves all those SS7 outages triggered outside a communication facility due to a severed or damaged fiber. For example, if a construction crew severed fiber cables which contained A-links, then the trigger cause would be fiber cut.
- **Human Activity:** Human Activity comprised of all those outages where carrier or contractor personnel working within the facility accidentally triggered an SS7 outage. For example, if a technician drops a screw driver on a power breaker, resulting in power loss to A-links, then the trigger cause of this outage will be categorized as human activity.
- **Equipment failure:** The equipment failure category consists of SS7 outages where either equipment hardware or associated software failure triggered an outage. For example, if the timing card fails that provides timing information for the A-links, causing loss of synchronization, then the trigger cause of outage will be categorized as Equipment failure (hardware). An example of software failure can be the failure of software in an SCP which impaired SS7 signaling capability.

# Trigger Causes (Continued)

- **Power source:** Power source comprised of those SS7 outages in which a power anomaly/failure, not caused by carrier personnel or contractors, caused SS7 component failure. For example, if the SS7 outage occurs due to loss of power to an STP, then it would be categorized under power source trigger category.
- **SS7 network overload:** Sometimes congestion in SS7 components causes impaired or lost SS7 signaling capability. The trigger cause of these outages is referred to as SS7 network overload. For instance if the SS7 traffic in an SCP increases beyond capacity causing SCP impairment and finally SS7 outage due to SCP's inability to process 800 calls, then the trigger cause of this outage would be categorized as overload.
- **Environmental factors:** If an outage is triggered by an earthquake, storm, vegetation, water ingress or HVAC failure, then they are categorized under environmental factors.
- **Unknown:** If the trigger cause cannot be determined from the report, it is categorized as unknown.

# Direct causes

- **SCP Failure:** Failure/Malfunction of either SCP or the software associated with it is categorized under SCP failure.
- **STP Failure:** Failure/Malfunction of STPs is categorized under STP failure.
- **SS7 Network Failure:** SS7 network failure consists of failure of C-links, D-links or any other link associated with SS7 network, other than A-links.
- **Switch SS7 process Failure:** Failure of the software or the processor inside the switch that provides switch SS7 capability is termed as Switch SS7 process failure. In addition, any failure associated with routing translations in a switch is also included in this category. For example, the deletion of routing entries from the switch or addition of wrong entries is classified as a switch SS7 process failure.

# Direct causes (continued)

- **A-Link Failures:**
  - **Direct Link Failure:** Failure of end to end A-link is categorized under direct link failure.
  - **DACS Failure:** DACS is a digital access and cross-connect switch. Failure of DACS which causes A-link failure is categorized under DACS failure. DACS failure is shown in Figure 12.
  - **SONET ring Failure:** Failure of SONET ring associated with A-links is categorized under SONET ring failure.
  - **MUX Failure:** SS7 outage due to failure of multiplexers which further causes loss of A-links is categorized under MUX failure.
  - **Transmission Clock Failure:** Transmission clock provides clocking information for the A-links. Failure of this clock is categorized under transmission clock failure.
  - **Switch A-link interface Failure:** By switch A-link interface we mean an interface which connects A-links to the switch. It is also sometimes called 'Common Network Interface (CNI)'. Failure of CNI interface is categorized under Switch A-link interface failure.
- **Unknown:** This category involves all those outages where the report doesn't provide enough information that can be used to categorize them under any of the direct causes.

# Root cause categories/subcategories

- **Procedural Error:** A procedure is a “series of actions conducted in a certain manner”. Thus, a procedural error is a failure to follow an established procedure. This category involves outages where the carrier technician/vendor/worker/contractor did not follow the correct process to accomplish a task.
- **Maintenance Error:** Maintenance is “The work of keeping something in proper condition”. Maintenance here means keeping the equipment and the facility in proper condition in order to reduce any chances of outage. The outages that results from not maintaining either the equipment or the facility is categorized as maintenance error.
- **Design Errors:** Hardware design error involves improper use of flawed hardware equipment or improper deployment of equipment, whereas software design error involves software bugs, faults or bad firmware.
  - **Hardware Design Error:**
  - **Software Design Error**



# Root cause categories/subcategories

- **Diversity Deficit:** Diversity deficit implies the absence or lack of diversity in equipment, power, or links. The outages that occurred because of absence of diversity are categorized as a diversity deficit. Diversity deficit is further divided into subcategories based on the component which lacked diversity.
  - **Link diversity deficit** – This is where the SS7 outage occurred due to loss of both point-to-point A-links. For example, if the redundant A-links are carried on a single fiber sheath which is severed, then it implies diversity deficit of A-links. Similarly, lack of point-to-point C-link and D-links are subcategorized as a link diversity deficits. SS7 link diversity is also mentioned in one of the best practices [44].
  - **Power Diversity Deficit** – This is where an outage occurred because there was no power diversity to SS7 equipment. For example, A-links receive timing from timing source equipment. If the timing source equipment receives power from a single source, then the failure of power to the timing source equipment can cause an SS7 outage. This outage will be subcategorized as a power diversity deficit. Power diversity is also mentioned in one of the best practices [44].
  - **Diversity Deficit: Equip SPF** – This subcategory involves outages where there was an equipment single point of failure. For example, if a single DACS (equipment used for cross connecting A-links) carrying A-links, fails, as shown in Figure 12. Then the root cause of the outage will be the lack of diverse equipments to carry A-links. Hence, it would be categorized as an equipment SPF diversity deficit. Single point of failure is also mentioned in one of the best practices [44].
- **Unknown:** This category involves all those outages where the report does not provide enough information to categorize the root cause.

# SS7 jump point model

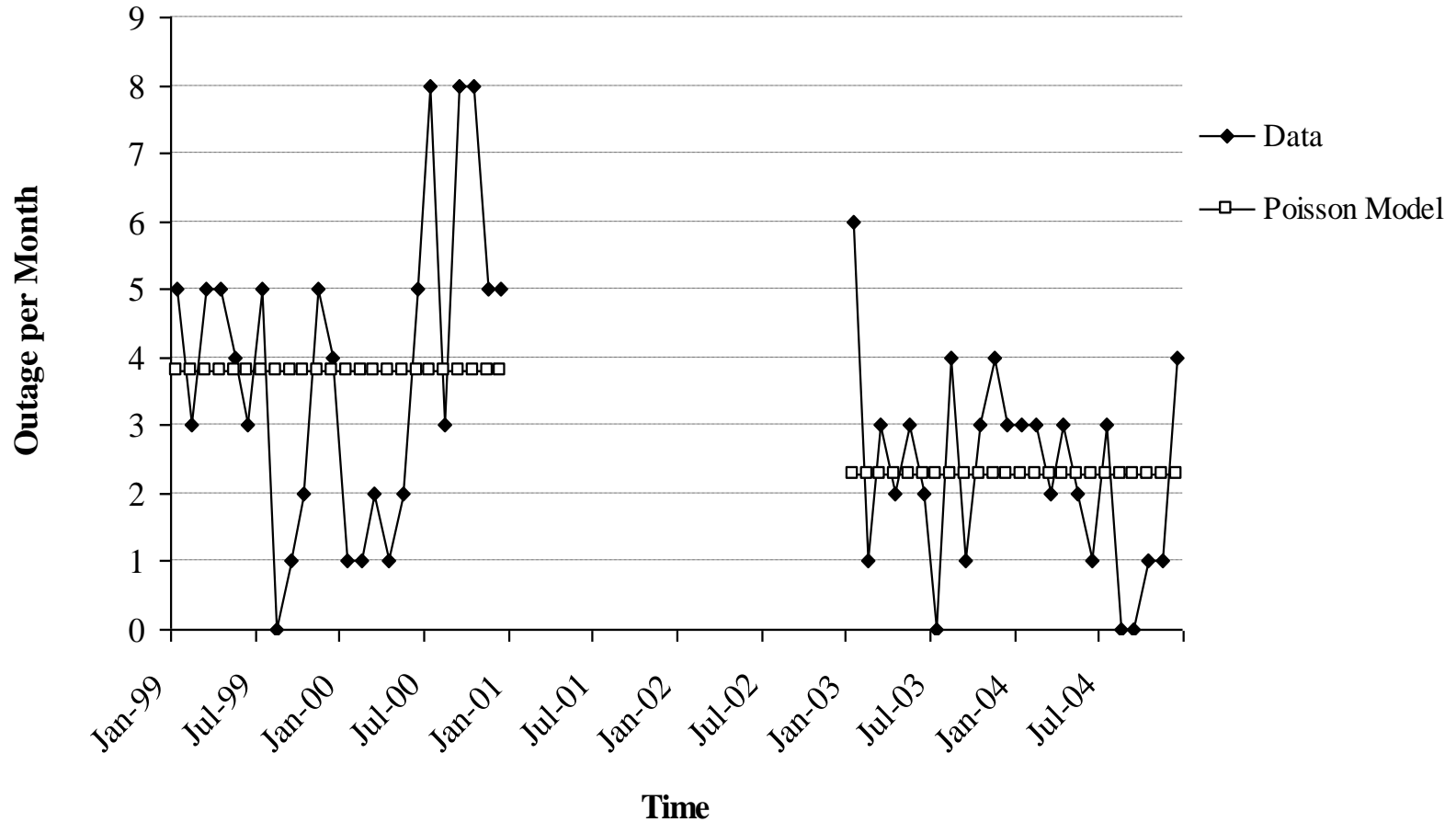

# Distribution of events into time slots before and after 9-11

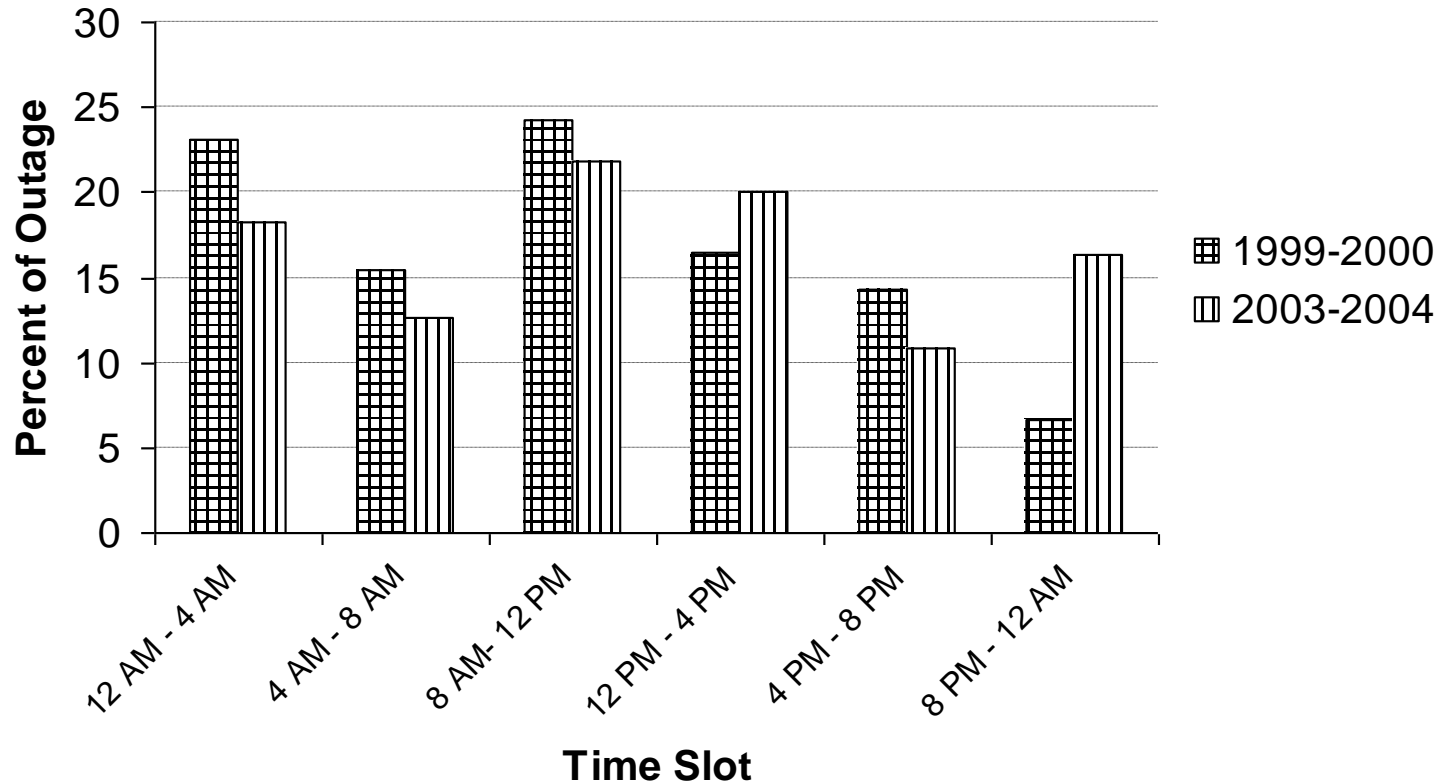

# Comparison for the day of week before and after 9-11

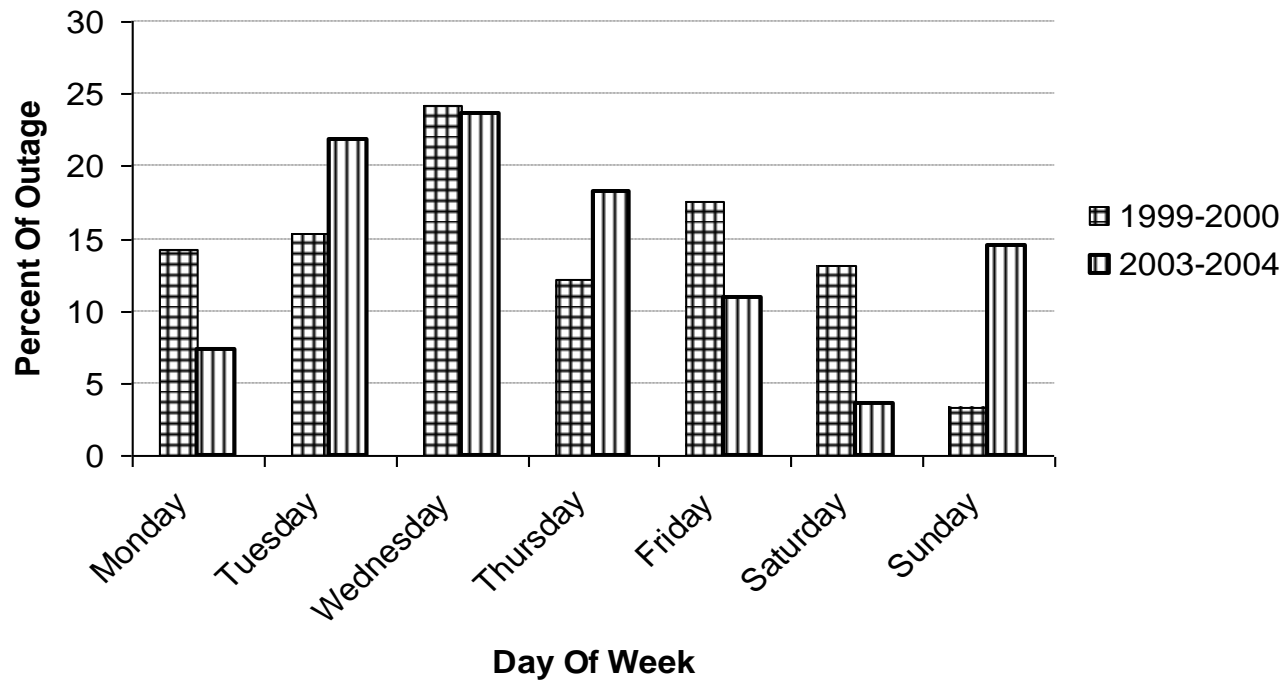

# Trigger cause: percent event distribution (pre and post 9-11)

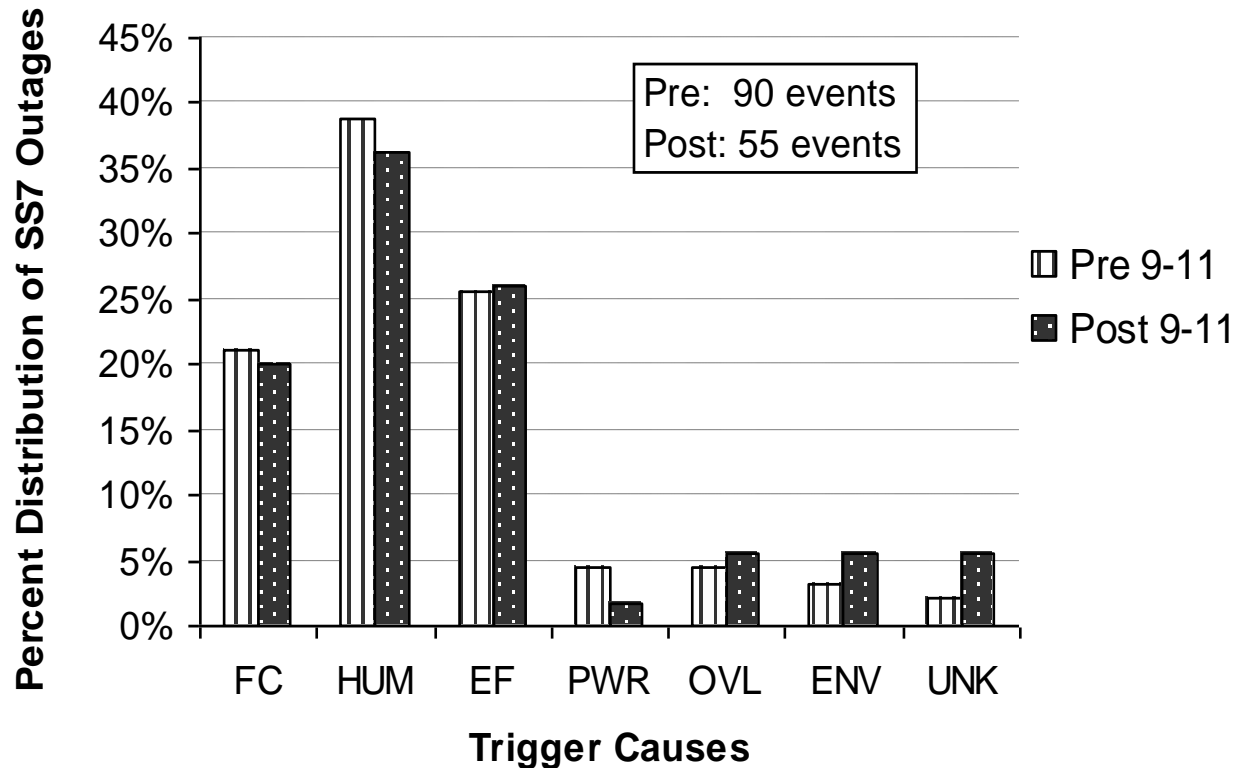

## Trigger Cause Frequency

Trigger Causes	Total Outages	Pre 9-11 Outages	Post 9-11 Outages
Human Activity	55	35	20
Equipment Failure	37	23	14
Fiber Cut	30	19	11
Power Source	5	4	1
Overload	7	4	3
Environment Error	6	3	3
Unknown	5	2	3
<b>Total</b>	<b>145</b>	<b>90</b>	<b>55</b>

## Direct Cause Frequency

Direct Causes	Total Outages	Pre 9-11 Outages	Post 9-11 Outages
A-link loss	111	69	42
Switch SS7 Process Failure	17	13	4
SCP Failure	9	6	3
STP Failure	3	1	2
Unknown	1	0	1
SS7 Network Failure	4	1	3
<b>Total</b>	<b>145</b>	<b>90</b>	<b>55</b>

## Root Cause Frequency

Root Causes	Total Outages	Pre 9-11 Outages	Post 9-11 Outages
Procedural Error	35	26	9
Diversity Deficit	69	39	30
Design Error	24	16	8
Facility Maintenance	12	7	5
Unknown	5	2	3
<b>Total</b>	<b>145</b>	<b>90</b>	<b>55</b>

# Outline

- A. Telecom & Network Infrastructure Risk**
- B. Telecommunications Infrastructure**
- C. RAMS: Reliability, Availability, Maintainability and Survivability**
- D. Protection Level Assessment & Forecasting**

# Thank You!!