

PESARO 2015 – PANEL Challenges on Reliability in (Tele)Communications

Moderator:
Wolfgang Leister, Norsk Regnesentral (Norway)

Panelists:
Ilias Iliadis, IBM Zürich Research Laboratory, Switzerland
Tapio Saarelainen, National Defence University, Finland
Stefano Olivieri, The MathWorks Inc., Italy
Jens Timmermann, Airbus DS GmbH, Germany



Panel-Introduction by W. Leister

Challenges on Reliability in (Tele)Communications

- Best Practice – how to achieve and maintain reliability
- The five nines
- Reliability of VoIP and Internet-based services
- Reliability of mobile networks
- M2M communication has different requirements ...
- Reliability in the cloud
- Reliability in emergency situations
- Reliability under extreme conditions
- Reliability, Security, QoS, QoE, Qo?
- Perceived reliability
 - Customers go away when not satisfied
 - Metrics, measures, ...

Panel-Introduction by W. Leister

Idea to use the «Generic Assessment Framework» to assess perceived reliability.

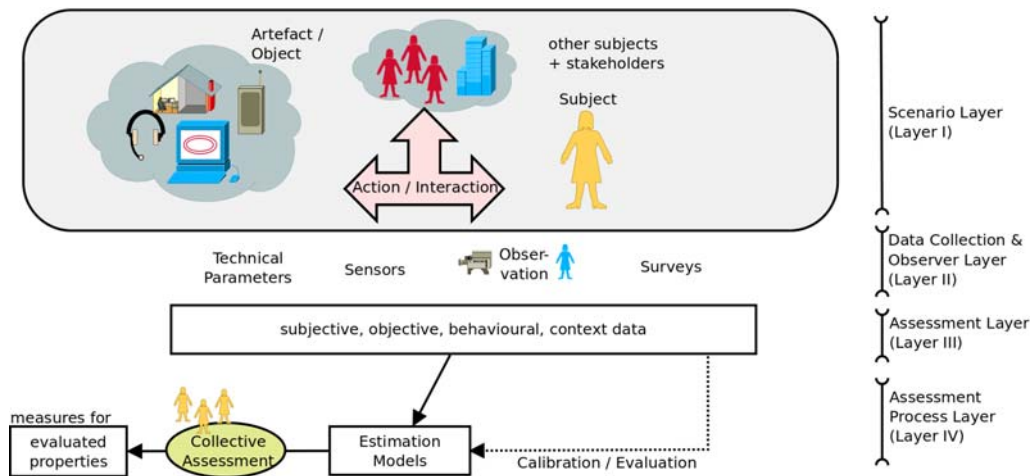

Panel-Introduction by W. Leister

Discussion points to panelists

- How can we achieve reliability in the domain you are discussing?
- How can we manage reliability in the domain you are discussing?
- What are metrics to measure reliability in the domain you are discussing?
- How to test and measure?
- Cloud & Services
- Satellites
- Drones under hostile conditions
- Wireless systems
- Perceived vs. M2M





Zurich Research Laboratory

Cloud Storage Reliability

Ilias Iliadis
April 21, 2015

Panel on ICDT/COCORA/PESARO/CTRQ/SPACOMM

www.zurich.ibm.com

Storage Hierarchy of a Datacenter

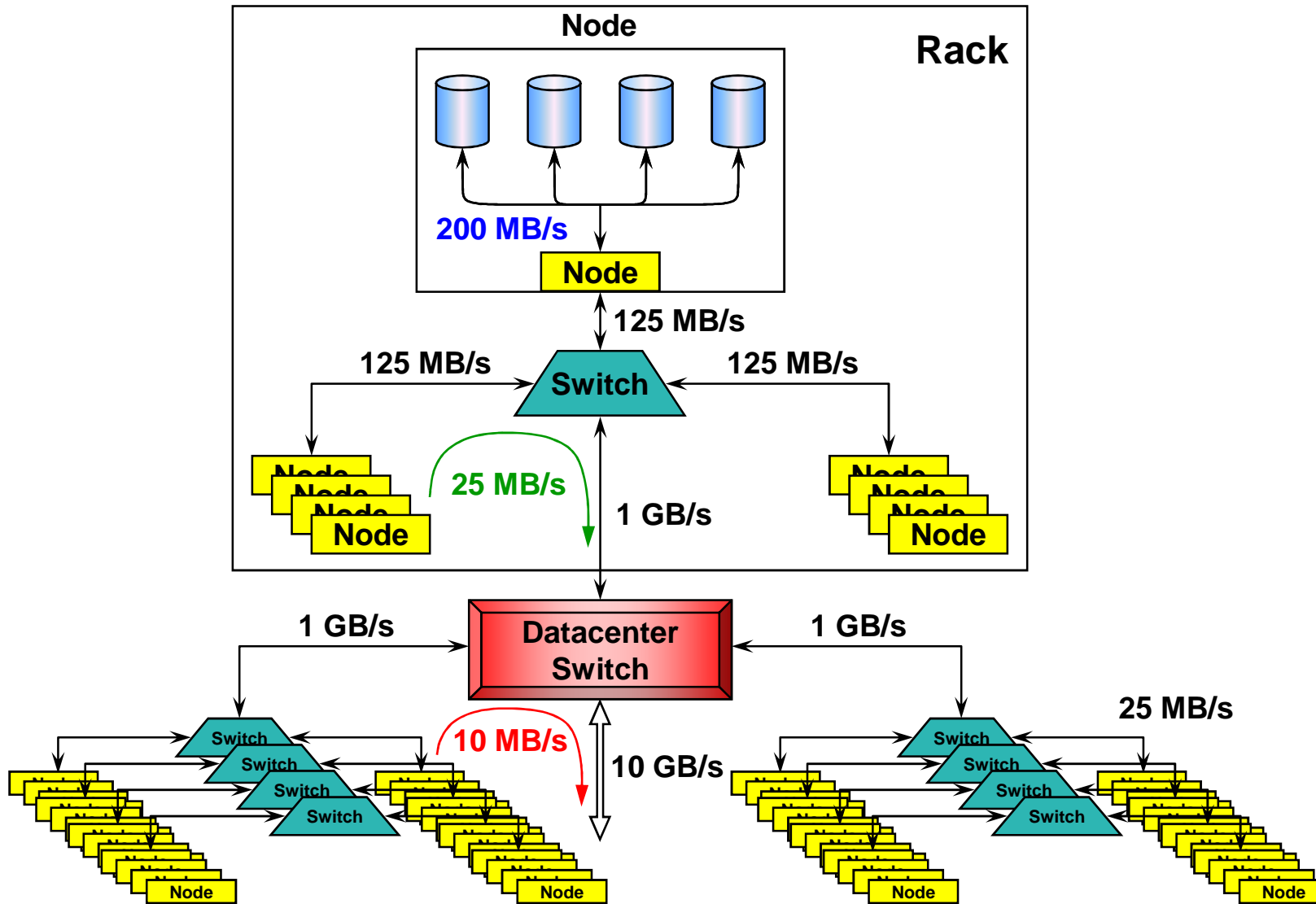

Reliability Issues

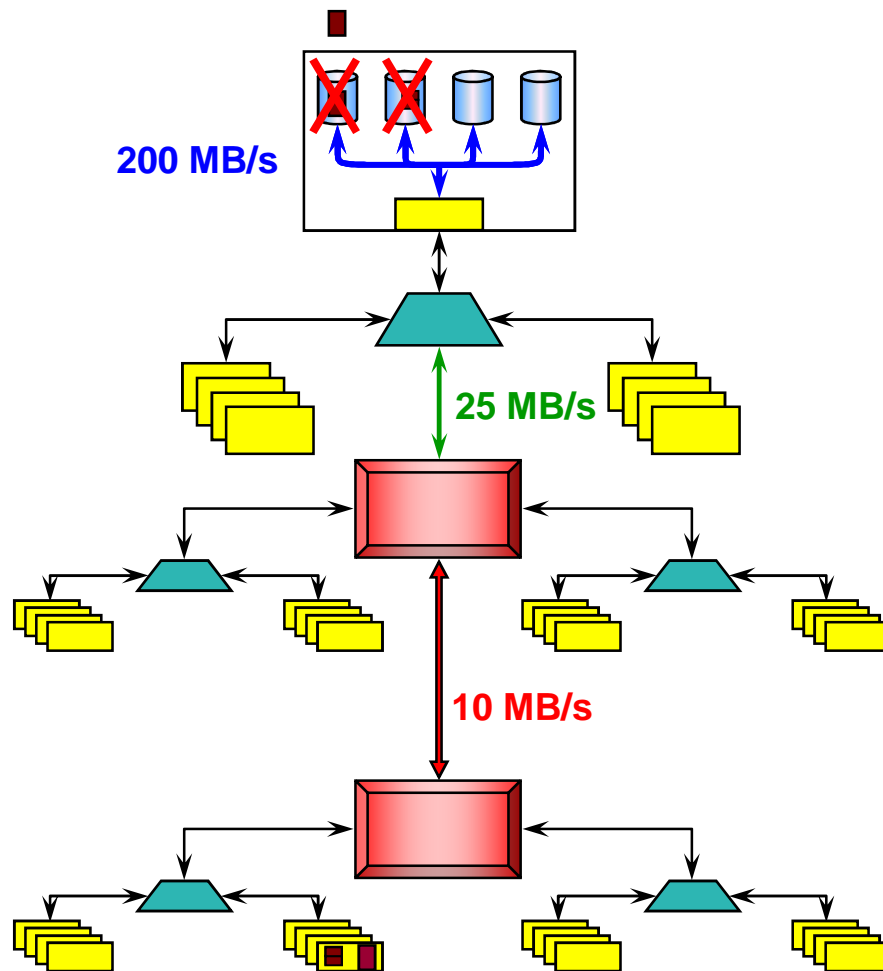

Reliability improvement through data replication

▪ Replica placement

- Within the same node
 - Fast rebuild at 200 MB/s (+)
 - Exposure due to disk failure correlation (-)
- Across datacenters
 - No exposure due to correlated failures (+)

▪ Rebuild process

- Direct rebuild to the affected node
 - Slow rebuild at 10 MB/s (-)
 - Long vulnerability window
- Staged rebuild
 - First local rebuild
 - Fast rebuild at 200 MB/s (+)
 - ✓ Short vulnerability window
 - Same location
 - ✓ Exposure due to correlated failures (0)
 - Replica then migrated to the affected node

▪ Replication factor

- How many replicas are required?

Tradeoffs of various placement and rebuild schemes

Design and testing methodologies for Wireless Communication Systems Reliability

Stefano Olivieri – Academic Group
MathWorks
stefano.olivieri@mathworks.it

Topics

- Landscape and main challenges for wireless communication systems design from a tool vendor perspective
- What system design and testing capabilities a tool vendor is expected to offer for reliable communication links
- Effective testing methodologies to meet physical layer design requirements and constraints

Trend: Broadband Mobile Communications LTE, 5G and beyond

- 5G R&D and standardization
 - 100-1000 times faster speeds
 - Reliable service everywhere
- Greater complexity
 - New architectures
 - New frequency bands (mmWave)
 - More antennas (massive MIMO)
 - Advanced RF and DSP co-design
- Involved Industries
 - Communications Infrastructure and Devices
 - AeroDef
 - Semiconductor



Trend: Connected Smart Devices

➤ Internet of Things

- Embedded sensors
- Digital health
- Industrial instruments

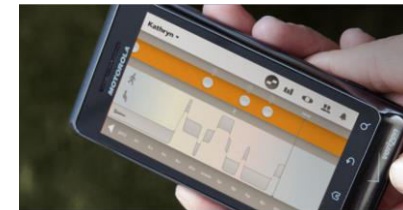

➤ Characteristics

- Connected wirelessly to internet
- Machine-to-machine communication
- Low power
- Generate lots of data

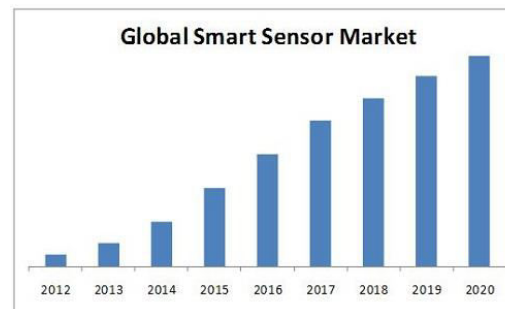

Wireless Communications Design Challenges

- Need multi-domain (Digital, RF, Antenna) knowledge
- Jointly optimize Digital Baseband, RF circuits and antenna patterns
- Simulate first with channel modelling. Is your channel model accurate?
- Test it with over-the-air transmission and reception of RF signals

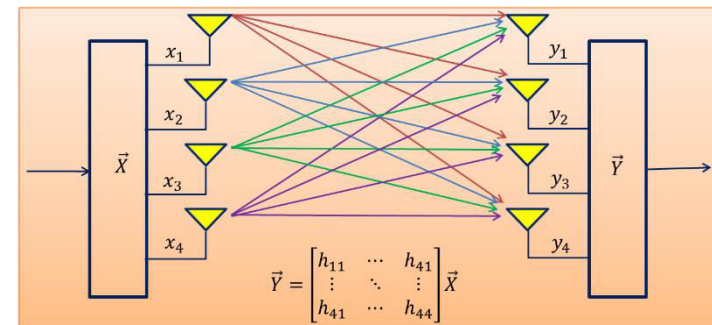
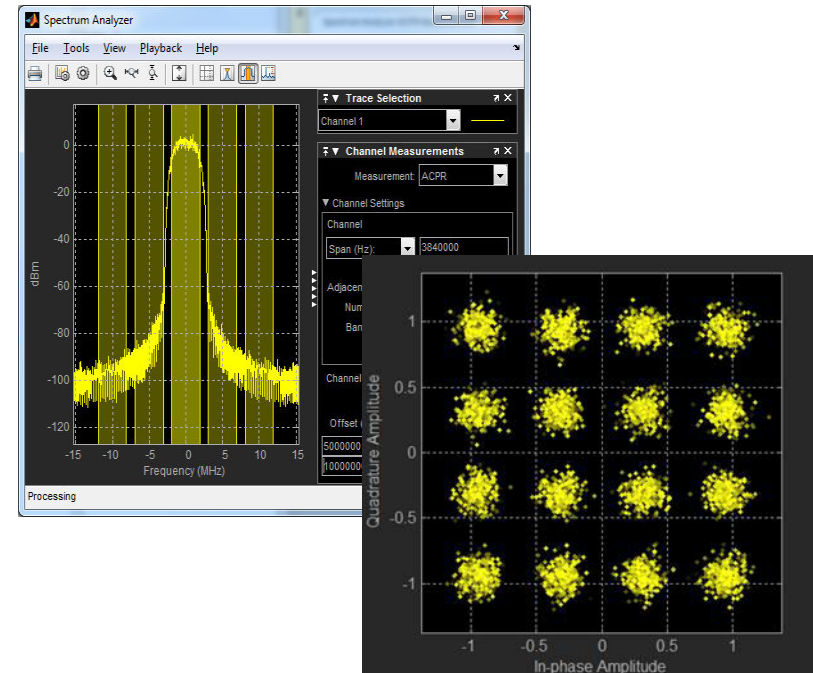

R&D and Product Development Challenges

- Complexity: new demands on engineers
 - Researchers and research engineers
 - Deliver IP and proof-of-concept faster
 - Design engineers
 - Design and integrate multi-domain systems
 - Test/validation engineers
 - Test conformance to complex standards and requirements

- Multiple tools, broken workflow: adds cost, delay, and risk
 - In-house: incomplete, poorly documented, hard to maintain
 - Different tools for digital and RF, simulation and lab
 - Inflexible test software, locked to expensive instruments

Focus on Physical Layer and RF

Smartphone Apps

Application Layer

Network Protocols

Radio Link Control (RLC)

Resource Allocation

Medium Access Control (MAC)

Signal Processing
HW & SW

Physical Layer

Expected system design and testing capabilities

- End-to-end system simulation
- Transmit & receive real wireless signals
- Connect to SDR equipment
- Connect to RF instruments
- Perform over-the-air testing
- Verify your wireless designs

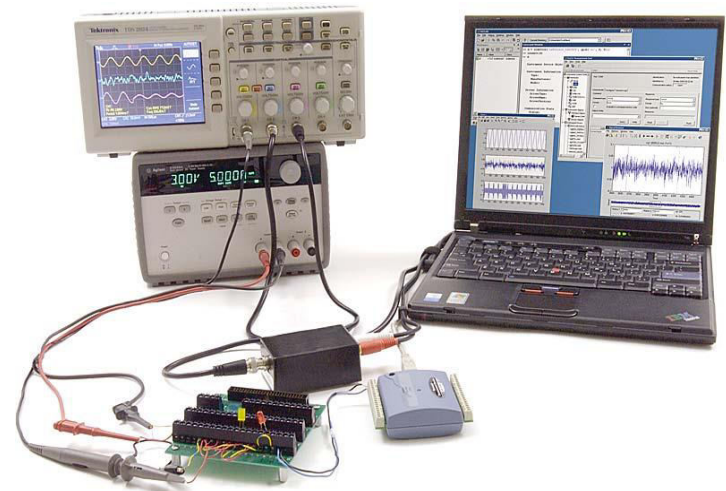

Examples of testing methodologies to meet expectations

- Antenna-to-Bits Simulation
- Smart RF Design
- Over the Air Testing with Radio Hardware
- Airborne & Automotive RADAR

Antenna-to-Bits Simulation

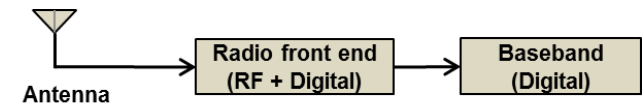

Simulate a complete wireless link

- Design modern wireless systems with components such as MIMO, OFDM, and adaptive beam-forming
- Analyze signals and make measurements such as EVM, ACLR, BLER, Throughput
- Generate waveforms and create verification references for downstream implementation

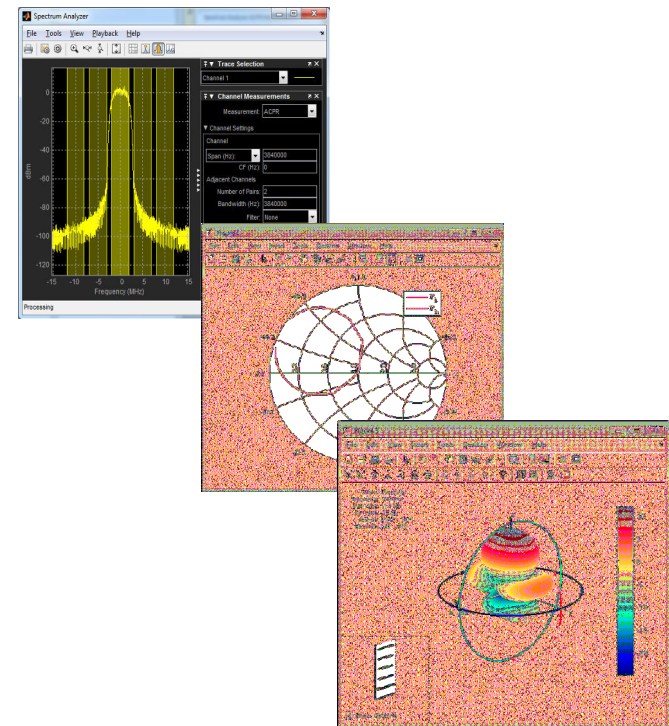

Smart RF design

Fast behavioral RF modeling & simulation

- Model and simulate RF transceiver together with baseband algorithms
- Develop calibration and control algorithms such as DPD or AGC to mitigate impairments and interferers
- Add measured RF component characteristics
- Use circuit envelope techniques to accelerate simulation of RF transceivers

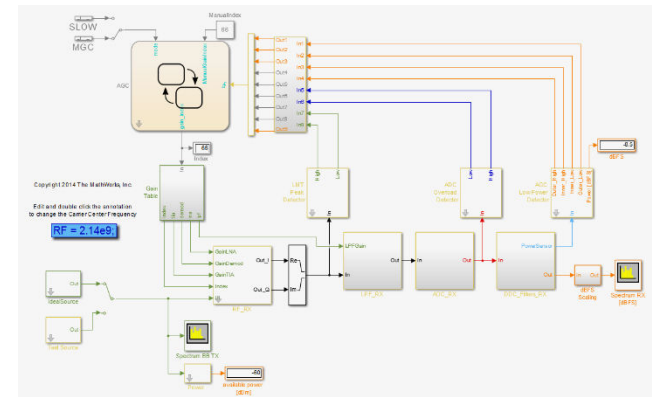

[Analog Devices AD9361](#)
RF Agile Transceiver™

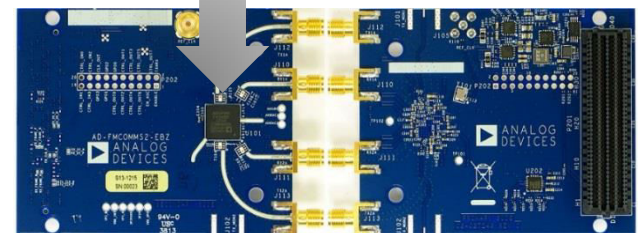

Over-the-air Testing with Radio Hardware

Transmit and receive live radio signals

- Transmit and receive generated waveforms
- Configure hardware parameters for a range of center frequencies and sampling rates
- Analyze acquired I/Q baseband signal with configurable measurement tools
- Verify and validate your designs based on live radio signals



Zynq SDR



RF Signal Generator



Spectrum Analyzer

Example: Over-the-air testing with SDRs & RF instruments

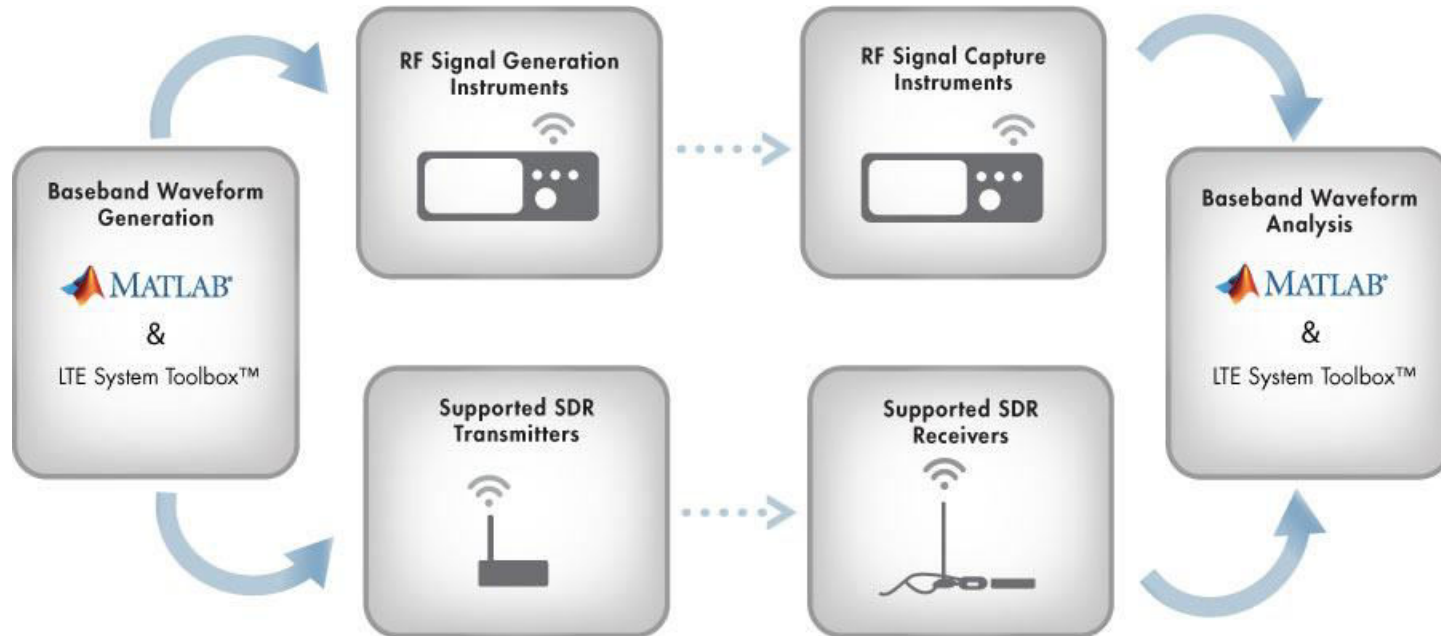

Process original data bits and generate custom digital baseband waveforms in transmitter

Transmit waveform using SDR devices or RF instruments

Capture received samples with SDR devices or RF instruments

Process received samples in receiver. Decode/recover original data

Airborne & Automotive RADAR

Simulate and test multi-domain RADAR systems

- Simulate ground-based, airborne, ship-borne, or automotive radar systems with moving targets and platforms
- Explore the characteristics of sensor arrays, and perform link budget analysis
- Accelerate development with a library of array processing algorithms such as beam-forming, DOA, range, and Doppler estimation and detection

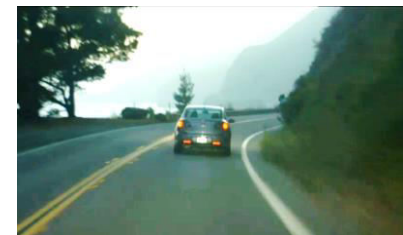
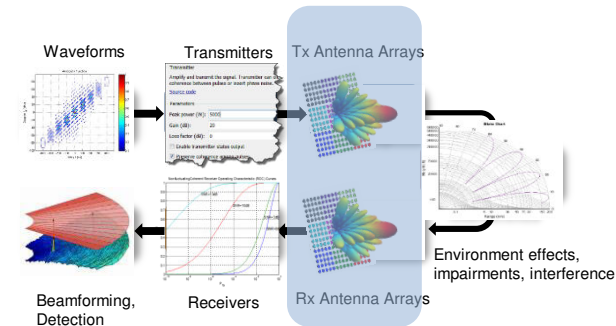

Thank You

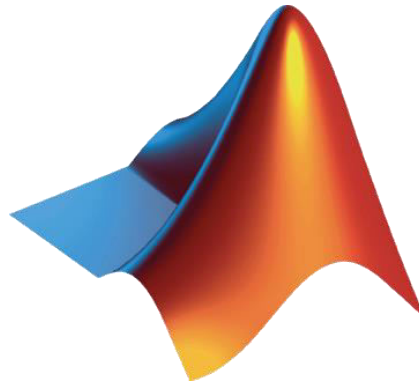

Q & A

Panel discussion related to Radio Frequency Compatibility (RFC) on-Board a Satellite

Dr.-Ing. Jens Christian Timmermann
Airbus Defence and Space, Friedrichshafen, Germany

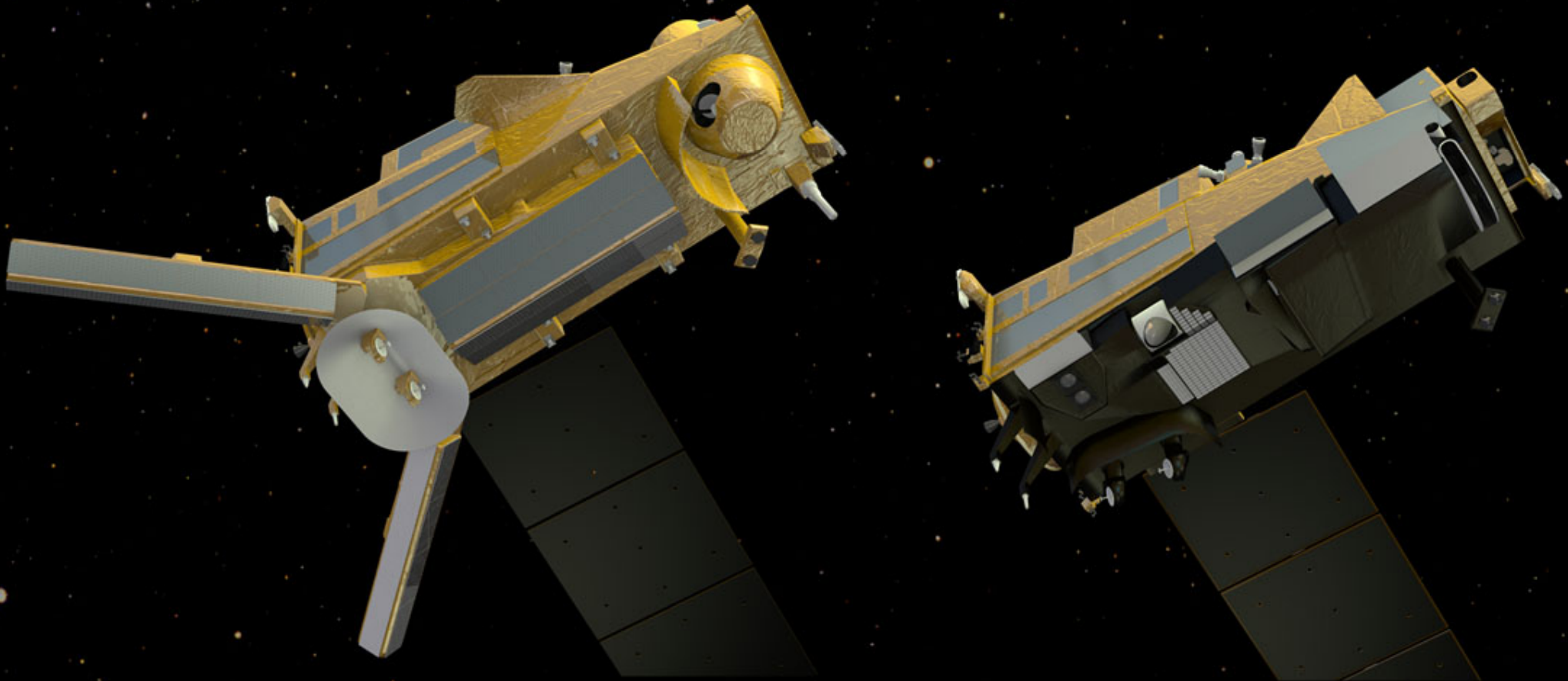

Radio Frequency Compatibility

- Future meteorological MetOp-SG satellites housing
 - Transmitters (Tx) for Downlink radiating in RF frequency range
 - Instrument receivers (Rx) intended for reception from Earth and sensitive in RF frequency range
- Ensuring On-Board Radio Frequency Compatibility (RFC) by sufficient decoupling between Tx and victim Rx; methods:
 - Sufficient distance between Tx / Rx
 - Optimized radiation pattern (minimizing radiating into Rx)
 - If received level (in dBm/Hz) above acceptable value (=RX sensitivity in dBm/Hz):
 - Insertion of baffle to shade the Line of Sight

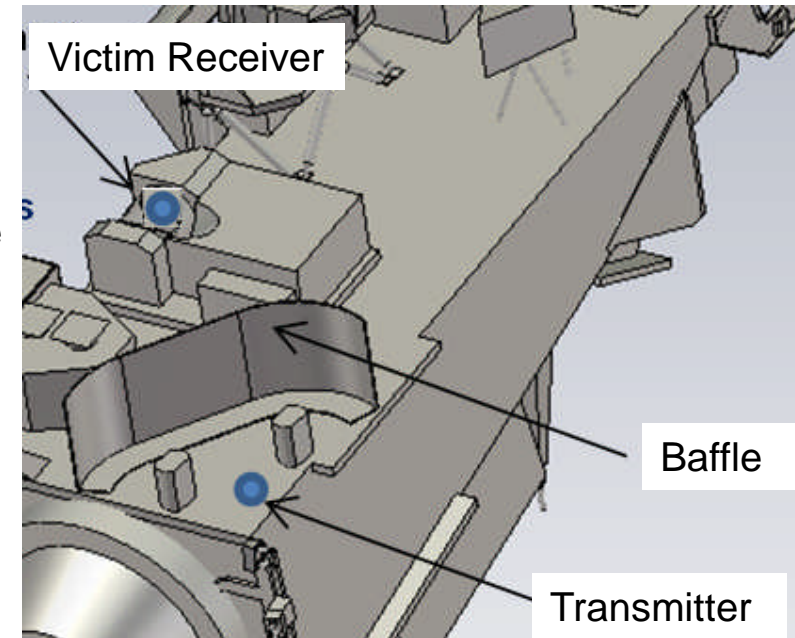

- Modelling of coupling factor C for Line of Sight (based on Friis equation for freespace propagation)

$$C = \frac{P_{Rx}}{P_{Tx}} = L \cdot G_{Tx}(\Theta_{Tx-Rx}) \cdot G_{Rx} \cdot \frac{c_0^2}{(4\pi \cdot d \cdot f)^2} \quad (1)$$

- L = harness loss between Rx antenna and Rx input

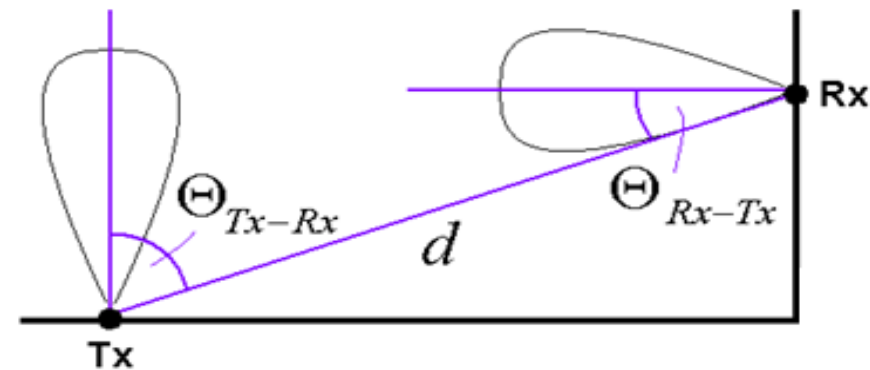

- Coupling factor assuming **No Line of Sight**:

$$C = \frac{P_{Rx}}{P_{Tx}} = L \cdot L_{Baffle} \cdot G_{Tx}(\Theta_{Tx-Rx}) \cdot G_{Rx} \cdot \frac{c_0^2}{(4\pi \cdot d \cdot f)^2} \quad (2)$$

Method to Estimate Tx/Rx Coupling for MetOp-SG Satellites

- Receive level [dBm/Hz] = Transmit_level [dBm/Hz] + C [dB] (3)

- RFC margin [dB] = Receiver_Sensitivity [dBm/Hz] - Receive_level [dBm/Hz] (4)

- Required RFC margin typ. > 25 dB for analysis

- Simplified methods required to estimate the coupling factor:

- Measurement of coupling factor not possible during study/design phase as satellite not built yet (but heritage antenna pattern may be known)

- Estimation of coupling factor for MetOp-SG

- Apply equation (2)

- Calculation of baffle attenuation: $L_{\text{baffle}} = 10^{(L_{\text{baffle,dB}} / 10)}$

- Either: Derive from field simulations: $L_{\text{baffle,dB}} = \text{“field strength at Rx without baffle (dBmV/m)”} - \text{“field strength at Rx in presence of baffle (dBmV/m)”}$
- Or: Calculate by knife-edge diffraction model

- Limitations:

- Equation (2) based on far field condition (Rx in far field of Tx)

Topics for Discussion

- **Topic 1: How to model the coupling factor in near field conditions?**

Approach for MetOp-SG: Power decay for ideal dipole in near field: $\sim 1/d^3$

Hence near field correction factor $[(1/d^3) / (1/d)^2] = 1/d$ to be taken into account in Equation (2)

- **Topic 2: Estimation of antenna gain at harmonic frequencies:**

Unintended spurious (harmonics) radiation into a victim Receiver:

- Coupling factor to be assessed at harmonic frequencies (requiring information on antenna gain)
- Antenna gain at these frequencies (multiples of design frequency)
 - often not known (no data from heritage design); e.g. not easy to measure (verification issue)
 - Difficult to simulate with appropriate accuracy:
High frequency: requires very fine 3D modelling, but may not be supported due to simulation time.
Example: Array of slotted waveguide antennas, designed for 5 GHz, but simulated at 90 GHz (minor approximations in modelling impact higher-order modes and radiation characteristics)
- How to estimate the antenna gain at harmonics?
 - In principle: Increase of antenna gain with frequency, but worse matching
→ Gain at harmonics comparable to gain at fundamental (or lower)
- Hence:
 - RFC analysis based on assumptions with uncertainty
 - Sufficient RFC margin required to cope with uncertainties
 - Verification by early testing: “Mock-up testing” using RF-representative antennas and representative part of satellite structure



Maasotakoulu

Challenges and solutions on reliability when using swarms of UAVs in data accruing process

PANEL DISCUSSION

Major Tapio Saarelainen, PhD, IARIA FELLOW

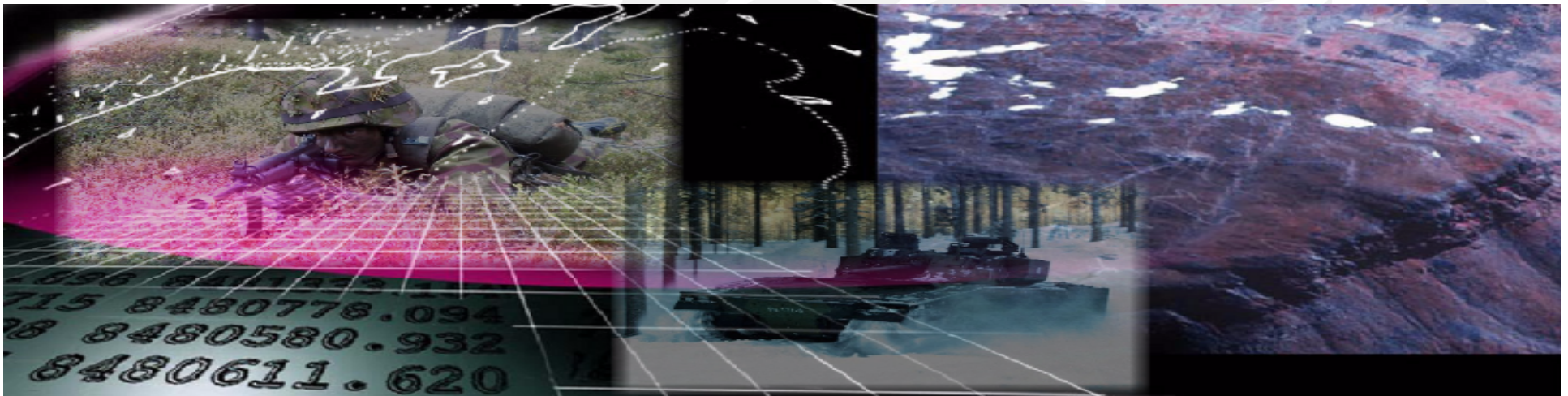

Puolustusvoimat

Försvarsmakten • The Finnish Defence Forces

14.5.2015

1



Unmanned Aerial Vehicles (UAVs)

Data gathering in progress...

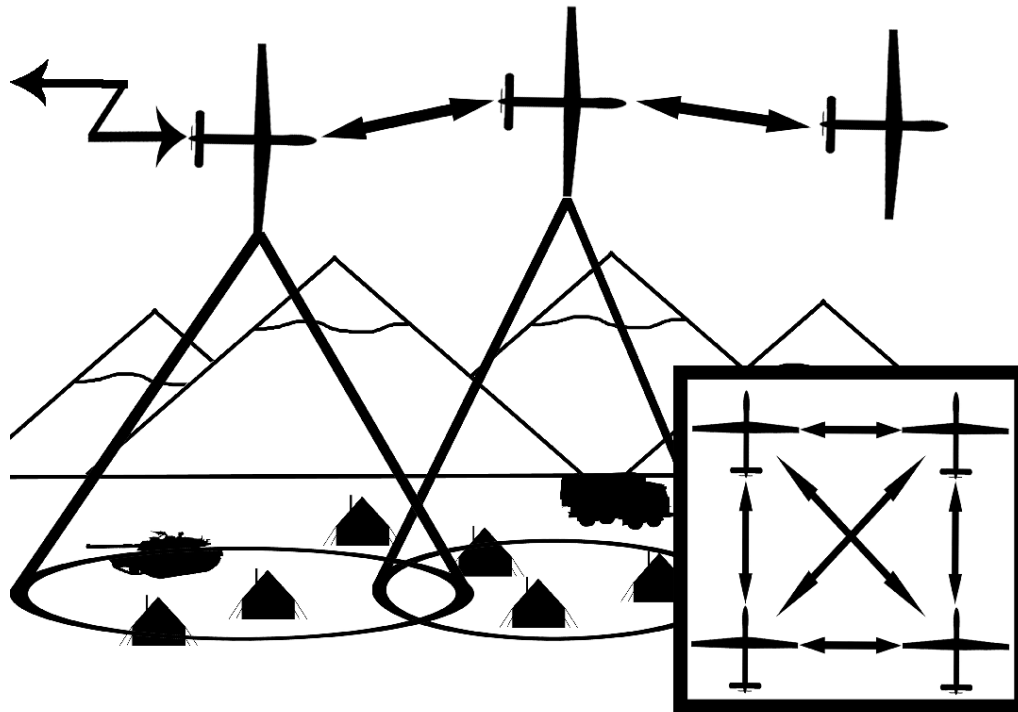
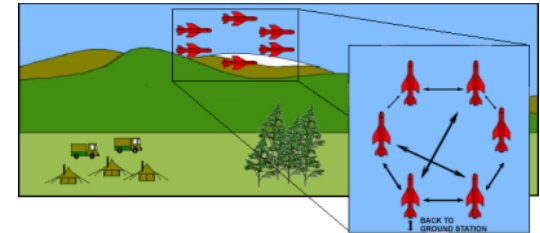

UAVs and the data transmission

Challenges:

- TIME!
- HUMAN LIVES!
- MISSION!
- Hostile environment
- Message throughput
- Latency times vary
- Communication frequency and bandwidth vary
- Transmission speeds
- Number of communication devices vary
- Challenges with bandwidth and energy



Nimi
Työ
Osasto



Communication

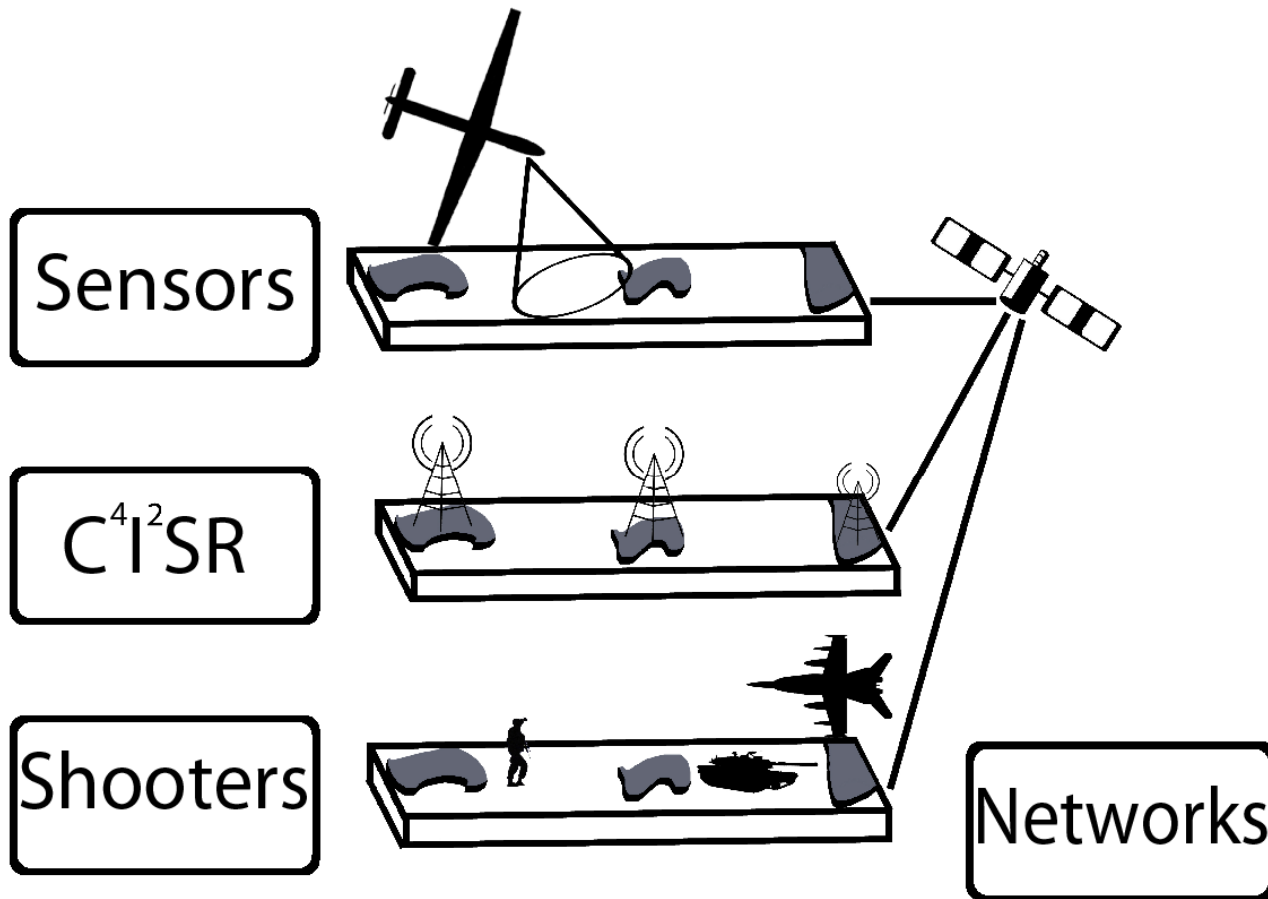

Communication network from sensor to shooter.





Military Decision Making Process (MDMP)

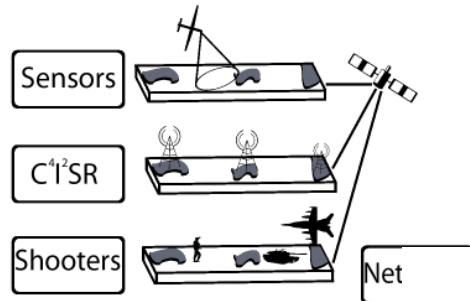

Raw data

$$v(x_j) = \sum_{i=1}^n w_i v_i(x_{ij})$$

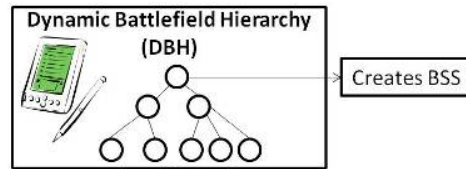

Deliver BSS messages over the network

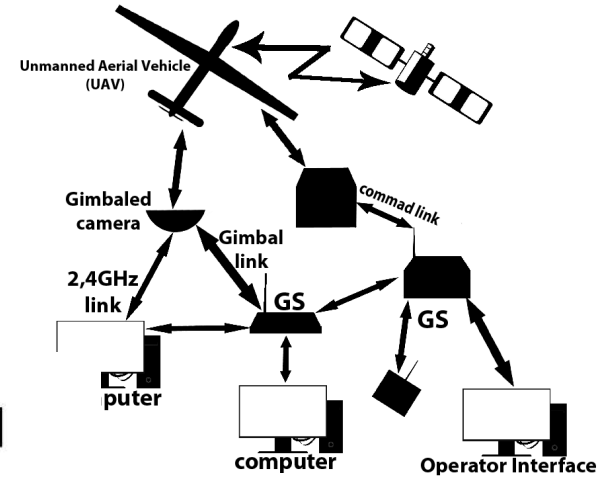

Processed data

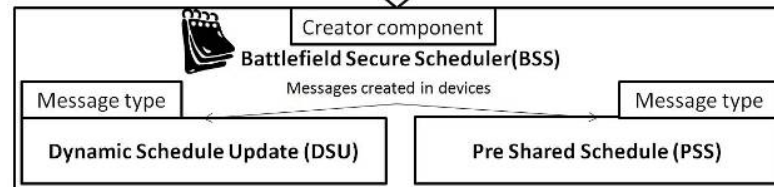

The processes inside MDMP.





Situational Awareness (SA) and Common Operational Picture (COP)

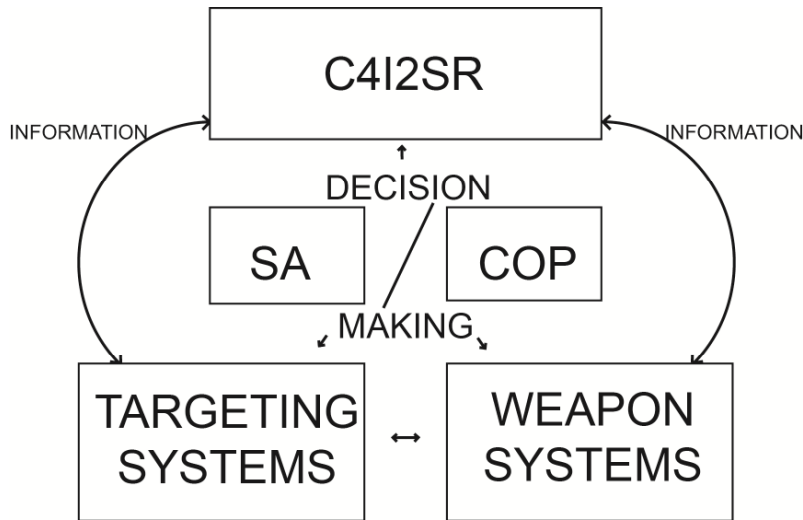

Decision making in applying targeting and weapon systems.

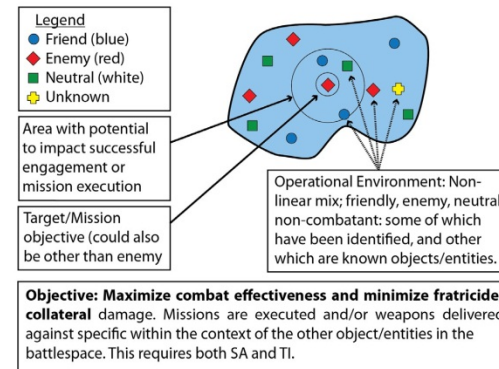

Challenges in weapon selection process.

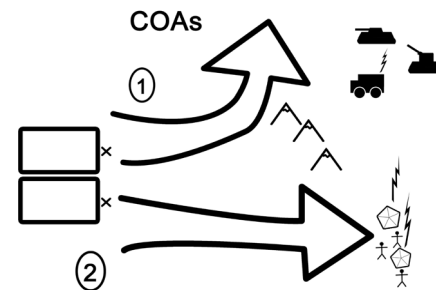

Different types of Courses of Action.





Solutions

Challenges:

- **TIME!**
- **HUMAN LIVES!**
- **MISSION!**
- **Hostile environment**
- **Message throughput**
- **Communication frequency and bandwidth vary**
- **Transmission speeds differ**
- **Number of communication devices vary**
- **Challenges with bandwidth and energy**

SOLUTIONS:

- **Planning and evaluation**
- **Mission security and operational planning**
- **MISSION EXECUTION**
- **Management of Electromagnetic Spectrum**
- **Ensuring throughput**
- **Planning and preparations**

- **Optimizing bandwidth and frequency**
- **Simplifying the number of devices**
- **Ensure energy sources and back-up power sources**
- **Maintaining the electromagnetic spectrum**



Objective

